



Southwire™

PUMP & IRRIGATION CATALOG



OUR STORY

As a family business, Southwire proudly continues building on our commitment to environmental stewardship and corporate sustainability by prioritizing stakeholder expectations, and supporting the wellbeing of our communities and the environment in which we live. To help us meet this commitment, we organize our sustainability strategy around five core tenets: Growing Green, Living Well, Giving Back, Doing Right, and Building Worth.

We Deliver Power...Responsibly®

We remain committed to the sustainability of our company for the next 100 years and beyond. As we strengthen this commitment, we continue to work hard every day to discover, develop and distribute sustainable solutions that exceed the expectations of our stakeholders around the world.

OUR MISSION

To be a **preferred provider** of solutions to the electrical industry by providing innovative products and services with exceptional quality.

OUR VALUES

Our **ONE Southwire** culture prioritizes the interests of our team members, customers, and communities through a continuous commitment to empowerment, trust, consistency, and inclusion.

OUR REACH

Nearly one in two new homes built in the United States contains our wire, and we produce half of the cable used to transmit and distribute electricity throughout the nation.

OUR PRODUCTS

Our product teams and dedicated resources work together to listen to and work with our customers, creating solutions that deliver unparalleled value through product innovation, safety and efficiency.

OUR SERVICE

Service is more than a word or a phone number; it's a tangible support system that assists you through the entire project cycle; from our knowledgeable customer service team, to our experienced field sales team, we're there every step of the way.



TABLE OF CONTENTS

PUMP & IRRIGATION WIRE

| | |
|-------------------------------|----|
| Pump & Irrigation Wires | 5 |
| Components | 23 |
| Hand Tools | 26 |
| Lighting | 33 |
| Extension Cords | 36 |

PUMP & IRRIGATION WIRE



FLAT JACKETED HEAVY DUTY TYPE THW

FLAT JACKETED HEAVY DUTY TYPE THW



APPLICATION

- For use in residential, farm, and industrial water well applications
- Grounded and ungrounded water well cable systems

CONSTRUCTION

- Premium 600 volt cable featuring stranded copper conductors with a moisture resistant PVC insulation
- Conductors are individually colored black, red, and yellow with green ground
- Insulated conductors are assembled parallel in a flat configuration and covered with a tough, black thermoplastic jacket

STANDARDS & REFERENCES

- Industry standard for electrical submersible pumping (ESP) water systems
- Meets NEC® code for submersible pump grounding requirements
- UL Standard 83
- UL Type THW Conductors

FEATURES

- Sequential footage marking on flat jacketed and parallel cables



PUMP & IRRIGATION WIRE

| STOCK # | DESCRIPTION | SIZE AWG & # OF CONDUCTORS | STRANDS | JACKET NOM THICKNESS (IN) | CABLE NOM DIMENSIONS (IN) | APPROX. WEIGHT (LB/MFT) | PACKAGE CODES |
|----------------|------------------------------|----------------------------|---------|---------------------------|---------------------------|-------------------------|---------------|
| With Ground | | | | | | | |
| 563675 | FLATJ 14/2 STR CU THW BK WG | 14/2 W/14 GR | 7 STR | 0.045 | 0.260 × 0.595 | 116 | AB |
| 563677 | FLATJ 14/3 STR CU THW BK WG | 14/3 W/14 GR | 7 STR | 0.045 | 0.255 × 0.765 | 151 | AB |
| 563678 | FLATJ 12/2 STR CU THW BK WG | 12/2 W/12 GR | 19 STR | 0.045 | 0.280 × 0.660 | 150 | ABC |
| 563679 | FLATJ 12/3 STR CU THW BK WG | 12/3 W/12 GR | 19 STR | 0.045 | 0.280 × 0.814 | 193 | AB |
| 563680 | FLATJ 10/2 STR CU THW BK WG | 10/2 W/10 GR | 19 STR | 0.045 | 0.310 × 0.730 | 202 | AB |
| 563681 | FLATJ 10/3 STR CU THW BK WG | 10/3 W/10 GR | 19 STR | 0.045 | 0.310 × 0.940 | 267 | AB |
| 563682 | FLATJ 8/2 STR CU THW BK WG | 8/2 W/10 GR | 19 STR | 0.06 | 0.370 × 0.850 | 280 | AB |
| 563683 | FLATJ 8/3 STR CU THW BK WG | 8/3 W/10 GR | 19 STR | 0.06 | 0.370 × 1.120 | 382 | AB |
| 563685 | FLATJ 6/3 STR CU THW BK WG | 6/3 W/8 GR | 19 STR | 0.06 | 0.404 × 1.282 | 530 | AB |
| 563686 | FLATJ 4/3 STR CU THW BK WG | 4/3 W/8 GR | 19 STR | 0.06 | 0.460 × 1.447 | 731 | AB |
| 563687 | FLATJ 2/3 STR CU THW BK WG | 2/3 W/6 GR | 19 STR | 0.06 | 0.512 × 1.656 | 1046 | AB |
| 563688 | FLATJ 1/0 3 STR CU THW BK WG | 1/0-3 W/6 GR | 19 STR | 0.08 | 0.610 × 2.170 | 1740 | AB |
| 563689 | FLATJ 2/0 3 STR CU THW BK WG | 2/0-3 W/6 GR | 19 STR | 0.08 | 0.680 × 2.425 | 2004 | AB |
| 583373 | FLATJ 4/0 3 STR CU THW BK WG | 4/0-3 W/6 GR | 19 STR | 0.06 | 0.800 × 2.814 | 2980 | D |
| 583378 | FLATJ 350 3 STR CU THW BK WG | 350 -3 W/6 GR | 37 STR | 0.08 | 0.955 × 3.508 | 4583 | D |
| Without Ground | | | | | | | |
| 563690 | FLATJ 10/2 STR CU THW BK WOG | 10/2 | 19 STR | 0.047 | 0.310 × 0.515 | 136 | AB |
| 568566 | FLATJ 12/3 STR CU THW BK WOG | 12/3 | 19 STR | 0.047 | 0.280 × 0.660 | 150 | A |
| 563691 | FLATJ 10/3 STR CU THW BK WOG | 10/3 | 19 STR | 0.047 | 0.310 × 0.730 | 202 | AB |
| 563693 | FLATJ 8/3 STR CU THW BK WOG | 8/3 | 19 STR | 0.047 | 0.370 × 0.910 | 310 | AB |
| 563694 | FLATJ 6/3 STR CU THW BK WOG | 6/3 | 19 STR | 0.047 | 0.404 × 1.012 | 424 | A |
| 563695 | FLATJ 4/3 STR CU THW BK WOG | 4/3 | 19 STR | 0.047 | 0.459 × 1.177 | 615 | A |

Package Codes:

- A - 1000' Reel
- B - 500' Reel
- C - 5,000' Reel
- D - MTOD - 5000' Reel

WE DELIVER POWER...RESPONSIBLY® | 5

FLAT PARALLEL TYPE THW

FLAT PARALLEL TYPE THW



APPLICATION

- For use in residential, farm, and industrial water well applications
- Grounded and ungrounded water well cable systems

CONSTRUCTION

- Premium 600 volt cable featuring stranded copper conductors with a moisture resistant plastic insulation
- Conductors are assembled parallel and yellow with black, red, and green extruded color stripes
- Conductor polarity is accomplished by extruded color green, red and black

STANDARDS & REFERENCES

- Industry standard for electrical submersible pumping (ESP) water systems
- Meets NEC® code for submersible pump grounding requirements
- UL Standard 83
- UL Type THN Conductors

FEATURES

- Footage marking on flat jacketed and parallel cables



**WE'VE GOT IT
MADE IN AMERICA™**

| STOCK # | DESCRIPTION | SIZE AWG & # OF CONDUCTORS | STRANDS | INSULATION NOM THICKNESS (IN) | CABLE NOM DIMENSIONS (IN) | APPROX. WEIGHT (LB/MFT) | PACKAGE CODES |
|-------------|-----------------------|----------------------------|-----------------|-------------------------------|---------------------------|-------------------------|---------------|
| With Ground | | | | | | | |
| 563658 | FLATP 14/2 STR CU WG | 14/2 | 7 STR W/GRD | 0.045 | 0.166 x 0.558 | 68 | AB |
| 563660 | FLATP 12/2 STR CU WG | 12/2 | 19 STR W/GRD | 0.045 | 0.185 x 0.615 | 95 | AB |
| 563662 | FLATP 10/2 STR CU WG | 10/2 | 19 STR W/GRD | 0.045 | 0.210 x 0.690 | 136 | AB |
| 563664 | FLATP 8/2 STR CU WG | 8/2 | 19 STR W/GRD | 0.06 | 0.027 x 0.809 | 206 | AB |
| 563659 | FLATP 14/3 STR CU WG | 14/3 | 7 STR W/GRD | 0.045 | 0.166 x 0.745 | 91 | AB |
| 563661 | FLATP 12/3 STR CU WG | 12/3 | 19 STR W/GRD | 0.045 | 0.185 x 0.830 | 126 | AB |
| 563663 | FLATP 10/3 STR CU WG | 10/3 | 19 STR W/GRD | 0.045 | 0.210 x 0.930 | 182 | AB |
| 563665 | FLATP 8/3 STR CU WG | 8/3 | 19 STR W/GRD | 0.045 | 0.270 x 1.109 | 277 | AB |
| 563666 | FLATP 6/3 STR CU WG | 6/3 | 19 STR W/GRD | 0.06 | 0.304 x 1.172 | 402 | AB |
| 563667 | FLATP 4/3 STR CU WG | 4/3 | 19 STR W/GRD | 0.06 | 0.365 x 1.490 | 568 | AB |
| With Ground | | | | | | | |
| 563669 | FLATP 14/2 STR CU WOG | 14/2 | 7 STR x 0.0242 | 0.045 | 0.166 x .062 | 46 | AB |
| 563671 | FLATP 12/2 STR CU WOG | 12/2 | 19 STR x 0.0185 | 0.045 | 0.185 x 0.402 | 63 | AB |
| 563672 | FLATP 12/3 STR CU WOG | 12/3 | 19 STR x 0.0185 | 0.045 | 0.185 x 0.118 | 95 | AB |
| 563673 | FLATP 10/2 STR CU WOG | 10/2 | 19 STR x 0.0234 | 0.045 | 0.209 x 0.448 | 91 | AB |
| 563674 | FLATP 10/3 STR CU WOG | 10/3 | 19 STR x 0.0234 | 0.045 | 0.210 x 0.690 | 136 | AB |

Package Codes:
A - 1000' Reel
B - 500' Reel

PUMP & IRRIGATION WIRE

TWISTED TYPE THW

TWISTED TYPE THW



APPLICATION

- For use in residential, farm, and industrial water well applications
- Grounded and ungrounded water well cable systems

CONSTRUCTION

- Premium 600 volt cable featuring solid and stranded copper conductors with a moisture resistant plastic insulation
- Conductors are twisted and colored black, red, and yellow when supplied with three conductors and green ground
- Cable is supplied without a jacket over the insulated conductors

STANDARDS & REFERENCES

- Industry standard for electrical submersible pumping (ESP) water systems
- Meets NEC® code for submersible pump grounding requirements
- UL Standard 83



| Stock # | DESCRIPTION | SIZE AWG & # OF CONDUCTORS | STRANDS | INSULATION NOM THICKNESS (IN) | CABLE NOM DIMENSIONS (IN) | APPROX. WEIGHT (LB/MFT) | STANDARD PACKAGE |
|----------------|----------------------------|----------------------------|---------|-------------------------------|---------------------------|-------------------------|------------------|
| With Ground | | | | | | | |
| 563703 | TWIST 14/2 SOL CU THW 14CG | 14/2 W/14 GR | Solid | 0.045 | 0.334 | 65 | AB |
| 563704 | TWIST 14/3 SOL CU THW 14CG | 14/3 W/14 GR | Solid | 0.045 | 0.373 | 87 | AB |
| 563705 | TWIST 12/2 SOL CU THW 12CG | 12/2 W/12 GR | Solid | 0.045 | 0.345 | 91 | AB |
| 563706 | TWIST 12/3 SOL CU THW 10CG | 12/3 W/12 GR | Solid | 0.045 | 0.414 | 122 | AB |
| 563707 | TWIST 10/2 SOL CU THW 10CG | 10/2 W/10 GR | Solid | 0.045 | 0.414 | 132 | AB |
| 563708 | TWIST 10/3 SOL CU THW 10CG | 10/3 W/10 GR | Solid | 0.045 | 0.462 | 176 | AB |
| 563709 | TWIST 8/2 STR CU THW 10CG | 8/2 W/10 GR | 19 STR | 0.06 | 0.574 | 195 | AB |
| 563710 | TWIST 8/3 STR CU THW 10CG | 8/3 W/10 GR | 19 STR | 0.06 | 0.610 | 270 | AB |
| 563711 | TWIST 6/3 STR CU THW 8CG | 6/3 W/8 GR | 19 STR | 0.06 | 0.646 | 402 | AB |
| 563712 | TWIST 4/3 STR CU THW 8CG | 4/3 W/8 GR | 19 STR | 0.06 | 3.141 | 565 | AB |
| 563713 | TWIST 2/3 STR CU THW 6CG | 2/3 W/6 GR | 19 STR | 0.06 | 3.662 | 853 | AB |
| Without Ground | | | | | | | |
| 584780 | Twist 12/3 Sol CU WOG | 12/3 | Solid | 0.047 | 0.377 | 92 | AB |
| 584782 | Twist 10/3 Sol CU WOG | 10/3 | Solid | 0.045 | 0.415 | 132 | AB |

Package Codes:
A - 1000' Reel
B - 500' Reel

PUMP & IRRIGATION WIRE

HI-LO SUPREME FLAT JACKET UL LISTED WATER WELL CABLE

HI-LO SUPREME PARALLEL TYPE UL LISTED WATER WELL CABLE



WE'VE GOT IT
MADE IN AMERICA™

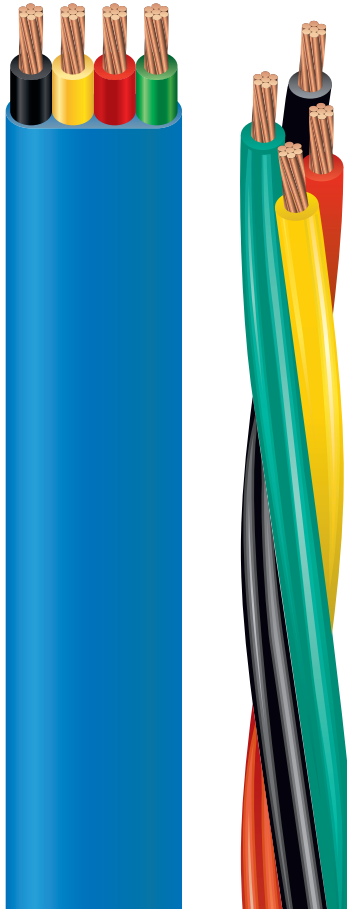

Rated -50°C to +105°C, 600V Extreme, Oil-Resistant, Moisture Resistant Conditions

APPLICATION

- For use in residential, farm, and industrial water well applications
- Used in both high temperature and low temperature wells
- Suitable for frigid North or Southern deserts - harsh environments

CONSTRUCTION

- Premium 600 volt cable featuring stranded copper conductors with a moisture resistant plastic insulation
- Insulated and jacketed with a premium thermoplastic elastomer (TPE) material
- Oil-resistant cable
- Temperature Rating: -50°C to +105°C; 75°C Wet; 60°C in Oil; 600 V
- Conductors are individually colored black, red, yellow and green
- Type Inner and Outer Jackets

COMPLIANCE

- Industry standard for electrical submersible pumping (ESP) water systems
- Meets NEC® code for submersible pump grounding requirements
- UL Standard 83

COMPLIANCE

- Grounded and ungrounded water well cable
- Footage marking on flat jacketed and parallel cables

HI-LO SUPREME PARALLEL TYPE UL LISTED WATER WELL CABLE

| STOCK # | DESCRIPTION | SIZE AWG & # OF CONDUCTORS | STRANDS | JACKET NOM THICKNESS (IN) | CABLE NOM DIMENSIONS (IN) | APPROX. WEIGHT (LB/MFT) | PACKAGE CODES |
|-------------|-------------------------|----------------------------|---------|---------------------------|---------------------------|-------------------------|---------------|
| With Ground | | | | | | | |
| 597856 | FLATJ 12/2 STR CU BE WG | 12-2 | 65 STR | 0.045 | 0.206 × 0.518 | 95 | AB |
| 597857 | FLATJ 12/3 STR CU BE WG | 12-3 | 65 STR | 0.045 | 0.206 × 0.678 | 127 | AB |
| 597860 | FLATJ 10/2 STR CU BE WG | 10-2 | 105 STR | 0.045 | 0.231 × 0.593 | 137 | AB |
| 597861 | FLATJ 10/3 STR CU BE WG | 10-3 | 105 STR | 0.045 | 0.231 × 0.774 | 182 | AB |
| 597864 | FLATJ 8/3 STR CU BE WG | 8-3 | 168 STR | 0.06 | 0.316 × 1.009 | 281 | AB |

HI-LO SUPREME TWISTED TYPE THW

| STOCK # | DESCRIPTION | SIZE AWG & # OF CONDUCTORS | STRANDS | NOM THICKNESS (IN) | CABLE NOM DIMENSIONS (IN) | APPROX. WEIGHT (LB/MFT) | PACKAGE CODES |
|-------------|--------------------------|----------------------------|---------|--------------------|---------------------------|-------------------------|---------------|
| With Ground | | | | | | | |
| 563697 | HLTwist 12/2 Str CU 12CG | 12-2 W/GRD | 19 STR | 0.03 | 0.405 | 89 | AB |
| 563699 | HLTwist 10/2 Str CU 10CG | 10-2 W/GRD | 19 STR | 0.03 | 0.455 | 130 | AB |
| 563698 | HLTwist 12/3 Str CU 12CG | 12-3 W/GRD | 19 STR | 0.03 | 0.455 | 119 | AB |
| 563701 | HLTwist 10/3 Str CU 10CG | 10-3 W/GRD | 19 STR | 0.03 | 0.509 | 173 | AB |
| 563702 | HLTwist 8/3 Str CU 10CG | 8-3 W/GRD | 19 STR | 0.03 | 0.581 | 249 | AB |

ROUND TWISTED JACKETED TYPE THW

ROUND TWISTED JACKETED TYPE THW

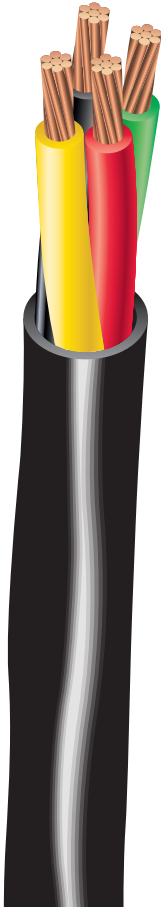

75°C, 600V, Water Well Cable, Moisture Resistant, Plastic Insulation, Round Configuration, Black PVC Jacket

APPLICATIONS

- For use in residential, farm, and industrial water well applications

CONSTRUCTION

- Premium 600 volt cable featuring stranded copper conductors with a moisture resistant plastic insulation
- Conductors are individually colored black, red, yellow with a green ground
- Insulated conductors are assembled in a round configuration and covered with a tough, black thermoplastic jacket

STANDARDS & REFERENCES

- Industrial standard for electrical submersible pumping (ESP) water systems
- Meets NEC® code for submersible pump grounding requirements
- UL 83

FEATURES

- Grounded and ungrounded water well cable
- Footage marking



| STOCK # | DESCRIPTION | SIZE AWG & # OF CONDUCTORS | STRANDS | JACKET NOM THICKNESS (IN) | CABLE NOM DIMENSIONS (IN) | APPROX. WEIGHT (LB/MFT) |
|----------------|----------------------------|----------------------------|-----------------|---------------------------|---------------------------|-------------------------|
| With Ground | | | | | | |
| 566483 | RoundJ 12/3 Str CU THW WG | 19 Str W/Grd | 12 3/C W/ 12 GR | 0.045 | 0.494 | 150 |
| 566484 | RoundJ 10/3 Str CU THW WG | 19 Str W/Grd | 10 3/C W/ 10 GR | 0.045 | 0.55 | 209 |
| 566485 | RoundJ 8/3 Str CU THW WG | 19 Str W/Grd | 8 3/C W/ 8 GR | 0.06 | 0.67 | 346 |
| 566486 | RoundJ 6/3 Str CU THW WG | 19 Str W/Grd | 6 3/C W/ 6 GR | 0.06 | 0.706 | 418 |
| 566487 | RoundJ 4/3 Str CU THW WG | 19 Str W/Grd | 4 3/C W/ 4 GR | 0.06 | 0.847 | 583 |
| Without Ground | | | | | | |
| 584705 | RoundJ 12/3 Str CU THW WOG | 19 Str WOG | 12 3/C | 0.045 | 0.448 | 105 |
| 584707 | RoundJ 10/3 Str CU THW WOG | 19 Str WOG | 10 3/C | 0.045 | 0.499 | 148 |
| 584708 | RoundJ 8/3 Str CU THW WOG | 19 Str WOG | 8 3/C | 0.06 | 0.628 | 258 |
| 584709 | RoundJ 6/3 Str CU THW WOG | 19 Str WOG | 6 3/C | 0.06 | 0.706 | 549 |
| 584710 | RoundJ 4/3 Str CU THW WOG | 19 Str WOG | 4 3/C | 0.06 | 0.807 | 779 |

PUMP & IRRIGATION WIRE

COPPER UF-B

COPPER UF-B



WE'VE GOT IT
MADE IN AMERICA™



Underground Feeder and Branch Circuit Cable. 600 Volt. Copper Conductors. Sunlight, Moisture, and Fungus Resistant Overall PVC Jacket.

APPLICATION

- Southwire copper UF-B cable is generally used as feeder to outside post lamps, pumps, and other loads or apparatus fed from a distribution point in an existing building.
- UF-B cable may be used underground, including direct burial.
- Multiple conductor UF-B cable may be used for interior branch circuit wiring in residential or agricultural buildings at conductor temperatures not to exceed 90°C (with ampacity limited to that for 60°C conductors).
- UF-B can be used in applications permitted for NMC.
- Voltage rating for UF-B cable is 600 volts.

STANDARDS & REFERENCES

Southwire copper UF-B cable complies with the following:

- ASTM - B3 and B-8
- UL Standard 83
- UL Standard 493
- Federal Specification A-A-59544
- National Electrical Code, NFPA 70, 2023 Edition
- RoHS/ REACH

CONSTRUCTION

- Southwire copper UF-B cable is manufactured as a 2 or 3 conductor cable, with or without a ground wire.
- Copper conductors are annealed (soft) copper, solid or compressed stranded.
- Phase conductors are polyvinyl chloride (PVC) insulated, nylon jacketed, color coded for identification purposes.
- Jacketed with sunlight, moisture and fungus resistant gray PVC.

| STOCK # | CONDUCTOR SIZE (AWG OR KCMIL) | NO. OF CONDUCTORS | NO. OF STRANDS | GROUND WIRE SIZE (AWG) | NO. OF GROUNDS | NOM. WIDTH (MILS) | NOM. HEIGHT (MILS) | INSULATION THICKNESS (MILS) | JACKET THICKNESS (MILS) | NOMINAL TOTAL WEIGHT (LBS/1000') |
|----------|-------------------------------|-------------------|----------------|------------------------|----------------|-------------------|--------------------|-----------------------------|-------------------------|----------------------------------|
| 13054201 | 14 | 2 | 1 | 14 | 1 | 423 | 168 | 15 | 30 | 71 |
| 13057501 | 14 | 3 | 1 | 14 | 1 | 581 | 168 | 15 | 30 | 97 |
| 13049201 | 12 | 2 | 1 | 12 | 1 | 386 | 183 | 15 | 30 | 71 |
| 13058301 | 12 | 3 | 1 | 12 | 1 | 626 | 183 | 15 | 30 | 131 |
| 13050001 | 10 | 2 | 1 | 10 | 1 | 440 | 215 | 20 | 30 | 102 |
| 13059101 | 10 | 3 | 1 | 10 | 1 | 727 | 215 | 20 | 30 | 191 |
| 20858701 | 8 | 2 | 7 | 10 | 1 | 678 | 302 | 30 | 45 | 222 |
| 14783501 | 8 | 3 | 7 | 10 | 1 | 1059 | 319 | 30 | 45 | 344 |
| 21469201 | 6 | 2 | 7 | 10 | 1 | 769 | 338 | 30 | 45 | 303 |
| 14782701 | 6 | 3 | 7 | 10 | 1 | 1223 | 361 | 30 | 45 | 479 |

PUMP & IRRIGATION WIRE

SPRINKLER SYSTEM CABLE

SPRINKLER SYSTEM CABLE



Rated 75°C, 30V, Solid Bare Copper , PE Insulation, Twisted Without Fillers, Overall Polyethylene

APPLICATION

- Southwire Sprinkler System Wire is suitable for direct burial on applications up to 30 volts
- Use with field and central controls in underground sprinkler systems
- The cable is rated -20°C to 75°C.

CONSTRUCTION

- Solid bare copper conductors with polyethylene insulation
- Twisted with overall polyethelene jacket



**WE'VE GOT IT
MADE IN AMERICA™**

| CONDUCTOR COLOR TABLE | | | |
|-----------------------|--|------------------|--|
| 1 Red | | 14 Red/White | |
| 2 White | | 15 Green/White | |
| 3 Green | | 16 Blue/White | |
| 4 Blue | | 17 Yellow/White | |
| 5 Yellow | | 18 Brown/White | |
| 6 Brown | | 19 Orange/White | |
| 8 Black | | 21 Pink/White | |
| 9 Pink | | 22 Gray/White | |
| 10 Gray | | 23 Tan/White | |
| 11 Tan | | 24 Purple/White | |
| 12 Purple | | 25 Natural/White | |
| 13 Natural | | | |

| STOCK # | DESCRIPTION | SIZE AWG & # OF CONDUCTORS | STRANDS | JACKET NOM THICKNESS (IN) | NOM DIMENSIONS (IN) | APPROX. WEIGHT (LB/MFT) | PACKAGE CODES |
|---------|-----------------|----------------------------|---------|---------------------------|---------------------|-------------------------|---------------|
| 54702 | 18/2 SOL CU BK | 18/2 | Solid | 0.026 | 0.174 | 16 | ABCD |
| 54704 | 18/4 SOL CU BK | 18/4 | Solid | 0.026 | 0.2 | 28 | ACE |
| 54705 | 18/5 SOL CU BK | 18/5 | Solid | 0.026 | 0.217 | 34 | ACE |
| 54706 | 18/6 SOL CU BK | 18/6 | Solid | 0.026 | 0.235 | 40.1 | BCF |
| 54707 | 18/7 SOL CU BK | 18/7 | Solid | 0.026 | 0.245 | 45.6 | BCF |
| 54708 | 18/8 SOL CU BK | 18/8 | Solid | 0.026 | 0.254 | 51.8 | BCDF |
| 54710 | 18/10 SOL CU BK | 18/10 | Solid | 0.026 | 0.296 | 64.2 | BCF |
| 54713 | 18/13 SOL CU BK | 18/13 | Solid | 0.026 | 0.322 | 81.8 | BCDF |
| 54716 | 18/16 SOL CU BK | 18/16 | Solid | 0.026 | 0.339 | 98.7 | BG |
| 54719 | 18/19 SOL CU BK | 18/19 | Solid | 0.026 | 0.357 | 116 | BG |
| 54725 | 18/25 SOL CU BK | 18/25 | Solid | 0.026 | 0.43 | | BG |

Package Codes:

A - 250' Spool in Carton C - 1000' Reel E - 500' Carton G - 250' Reel
B - 500' Reel D - 2500' Reel F - 250' Carton

PUMP & IRRIGATION WIRE

SPRINKLER / TRACER WIRE

SPRINKLER / TRACER WIRE

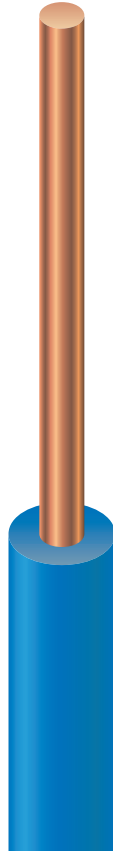

600V, PE 45 insulations, sprinkler or tracer wire 60C for direct burial

APPLICATION

- Southwire Golf Course Sprinkler / Tracer Wire is manufactured using solid soft drawn bare copper
- Single conductor cable suitable for direct burial on applications up to 600 volts for use as tracer wire for animal containment
- Polyethylene insulation

CONSTRUCTION

- Bare Copper Conductor
- -55°C to 60°C
- 18 AWG available colors: Yellow, Red, Green, Blue
- 12 and 14 AWG available colors: Yellow, White, Black, Green, Blue, Purple
- 16 AWG available colors: Yellow, White, Orange, Red, Black, Purple, Pink
- 10 AWG available colors: Green, Blue
- 8 AWG available colors: Yellow

COMPLIANCE

- ASTM B-8
- UL DIR BUR
- UL 66



PUMP & IRRIGATION WIRE

| STOCK # | DESCRIPTION | SIZE AWG | STRANDS | INSULATION NOM THICKNESS (IN) | NOM DIMENSIONS (IN) | APPROX. WEIGHT (LB/MFT) | PACKAGE CODES |
|---------|-------------|----------|---------|-------------------------------|---------------------|-------------------------|---------------|
| 54489 | 18 SOL CU | 18 | Solid | 0.047 | 0.134 | 10.1 | AB |
| 54490 | 16 SOL CU | 16 | Solid | 0.047 | 0.144 | 13.6 | BC |
| 54491 | 14 SOL CU | 14 | Solid | 0.047 | 0.157 | 19.6 | BC |
| 54492 | 12 SOL CU | 12 | Solid | 0.047 | 0.174 | 27.4 | AB |
| 54493 | 10 SOL CU | 10 | Solid | 0.047 | 0.193 | 40 | BC |
| 54494 | 8 SOL CU | 8 | Solid | 0.047 | 0.222 | 60 | D |

*Some colors and/or packages may be subject to MOQ.

Package Codes:
 A - 2500' Reel
 B - 500' Spool in Carton
 C - 1000' Carton
 D - 500' Reel

UL TYPE UF - UNDERGROUND FEEDER WIRE

UL TYPE UF - UNDERGROUND FEEDER WIRE



Rated -20°C to 60°C, 600V

APPLICATION

- Southwire Type UF Single Conductor and Low-Energy Circuit cable are suitable for landscape irrigation at conductor temperatures not to exceed 60°C
- Underground Feeder Cable for Direct Burial Applications

CONSTRUCTION

- Low-Energy Circuit cable applies to sizes 18 AWG and 16 AWG and is rated for 150 volts
- Solid bare copper conductor with PVC insulation
- 18 AWG available colors: White, Yellow, Red, Green, Blue, Black, Purple
- 16 AWG available colors: White, Orange, Red, Green, Blue, Black, Purple
- 14 AWG available in colors: White, Yellow, Orange, Red, Green, Blue, Black, Purple
- 12 AWG available in colors: White, Yellow, Red, Green, Blue, Brown, Black, Purple
- 10 AWG available in colors: White, Yellow, Green, Blue, Black, Purple

COMPLIANCE

- UL TYPE UF 600V -- C(UL) TWU 60°C FT1
- UL 493



| STOCK # | DESCRIPTION | SIZE AWG & # OF CONDUCTORS | STRANDS | INSULATION NOM THICKNESS (IN) | CABLE NOM DIMENSIONS (IN) | APPROX. WEIGHT (LB/MFT) | PACKAGE CODES |
|---------|------------------|----------------------------|---------|-------------------------------|---------------------------|-------------------------|---------------|
| 54499 | TWU/UF 18 SOL CU | 18 | Solid | 0.047 | 0.134 | 12.40 | AB |
| 54500 | TWU/UF 16 SOL CU | 16 | Solid | 0.047 | 0.140 | 15.70 | ABC |
| 54501 | TWU/UF 14 SOL CU | 14 | Solid | 0.062 | 0.187 | 27.20 | ABD |
| 54502 | TWU/UF 12 SOL CU | 12 | Solid | 0.062 | 0.202 | 35.52 | BE |
| 54503 | TWU/UF 10 SOL CU | 10 | Solid | 0.064 | 0.224 | 49.70 | BE |

*Some colors and/or packages may be subject to MOQ.

Package Codes:
 A - 500' Spools in Carton
 B - 2500' Reel
 C - 1000' Spools in Carton
 D - 1000' Carton
 E - 500' Carton

PUMP & IRRIGATION WIRE

LANDSCAPE LIGHTING ULEC

LANDSCAPE LIGHTING ULEC

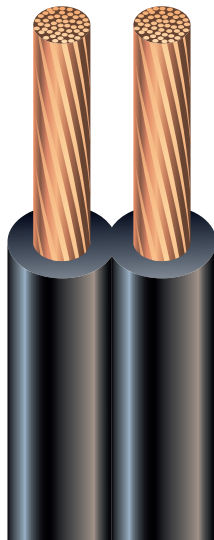

APPLICATION

- Outdoor Low-Voltage Underground Landscape Lighting Cable is designed for landscape, security, and Landscape Lighting Cable suitable for Direct Burial Stranded Copper Conductor Black PVC Insulation/Jacket.

CONSTRUCTION

- -20°C to +60°C, Underground Low Energy Circuit Cable 30vac
- 30VAC
- Two fully annealed bare stranded copper conductors
- Insulation/Jacket: Premium-grade PVC -20°C to +60°C
- Final assembly: Insulated/Jacketed conductors duplexed in a flat construction for easy tear-down during installation
- Color: Black

SPECIFICATIONS

- UL Underground Low-Energy Circuit Cable for Outdoor Lighting
- Meets UL Subj 1493
- EU RoHS Directive

| STOCK # | DESCRIPTION | SIZE AWG & # OF CONDUCTORS | NON. OVERALL DIA. (INCHES) | WEIGHT (LB/MFT) | WALL THICKNESS (MIL.) |
|---------|---------------------|----------------------------|----------------------------|-----------------|-----------------------|
| 55266 | ULEC 16/2 STR CU BK | 16/2 | 0.277 | 30.66 | 20 |
| 55267 | ULEC 14/2 STR CU BK | 14/2 | 0.318 | 42.6 | 20 |
| 55269 | ULEC 12/2 STR CU BK | 12/2 | 0.388 | 62.64 | 38.5 |
| 55272 | ULEC 10/2 STR CU BK | 10/2 | 0.382 | 85.6 | 30 |
| 55271 | ULEC 8/2 STR CU BK | 8/2 | 0.546 | 150.7 | 60 |

DECODER CABLE

DECODER CABLE

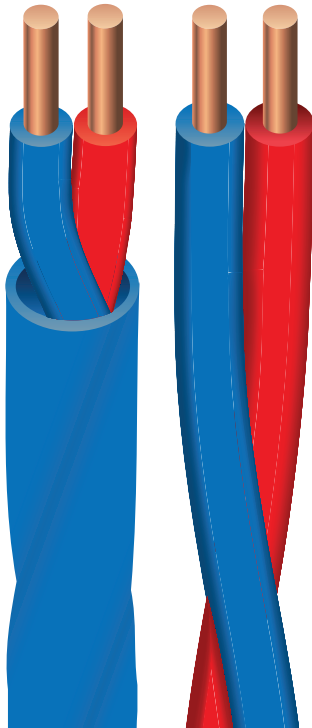

APPLICATION

Southwire Decoder Cables are suitable for MDC-50-200 and Site Control decoder systems used in large municipal turf areas and athletic fields.

CONSTRUCTION

With Jacket

- 45 mil insulation on the conductors
- Conductors are twisted and improves surge resistance
- Solid Bare Copper
- Insulation/Jacket PE
- Blue jacket. Orange available by request.

Without Jacket

- 60 mil installation on the conductors
- Conductors are twisted
- Solid Bare Copper

SPECIFICATIONS

- Southwire E217598 (0) 14 AWG 2/C (UL) 600 V Sprinkler Systems Wire 60°C Direct Burial RoHS
- RoHS

| STOCK # | SIZE (AWG) AND NUMBER OF CONDUCTORS | NOMINAL CONDUCTOR INSULATION DIAMETER (IN) | APPROX WEIGHT (1LBS/100FT) | PACKAGING (FT) | CONDUCTOR COLORS |
|--|-------------------------------------|--|----------------------------|----------------|------------------|
| DECODER CABLE - TWISTED WITH JACKET | | | | | |
| 571169 | 14/2 | 0.38 | 56 | 2500 | RED, BLUE |
| TBD | 12/2 | 0.41 | 75 | 1000, 2500 | RED, BLUE |
| DECODER CABLE - TWISTED WITHOUT JACKET | | | | | |
| TBD | 14/2 | 0.38 | 43 | 1000 | RED, BLUE |

Package Codes:
 01 - 1000SP
 02 - 2500R
 03 - 500SP

PUMP & IRRIGATION WIRE

THERMOSTAT WIRE - UNSHIELDED CL2/CMH

THERMOSTAT WIRE - UNSHIELDED CL2/CMH



APPLICATION

Thermostat Wire is a class 2 power-limited circuit cable for use in thermostat control applications.

CONSTRUCTION

- Solid copper conductors with 6 mils of HDPE insulation
- Conductors are covered with a FR PVC jacket, Brown
- Ripcord

SPECIFICATIONS

- 150 Voltage rating per NEC® Article 725
- ETL listed to UL 13 and UL 444
- Meets UL 1581 Vertical Tray Flame Test (FT-1)
- Type CL2
- C22.2 214 TYPE CMH



PUMP & IRRIGATION WIRE

| STOCK# | DESCRIPTION | AWG | #COND | JACKET COLOR | CONDUCTOR COLOR | RATING | OVERALL DIAMETER (MILS) | NET WEIGHT (LBS/1000FT) |
|--------|------------------------------------|-----|-------|--------------|--|--------|-------------------------|-------------------------|
| 55302 | TSTAT 18/2C SOL CU N/S CM/CL2 PVC | 18 | 2 | Brown | Red, White | CL2 | 132 | 13 |
| 55303 | TSTAT 18/3C SOL CU N/S CM/CL2 PVC | 18 | 3 | Brown | Red, White, Green | CL2 | 140 | 19 |
| 55304 | TSTAT 18/4C SOL CU N/S CM/CL2 PVC | 18 | 4 | Brown | Red, White, Green, Blue | CL2 | 154 | 25 |
| 55305 | TSTAT 18/5C SOL CU N/S CM/CL2 PVC | 18 | 5 | Brown | Red, White, Green, Blue, Yellow | CL2 | 170 | 30 |
| 55306 | TSTAT 18/6C SOL CU N/S CM/CL2 PVC | 18 | 6 | Brown | Red, White, Green, Blue, Yellow, Brown | CL2 | 186 | 36 |
| 55307 | TSTAT 18/7C SOL CU N/S CM/CL2 PVC | 18 | 7 | Brown | Red, White, Green, Blue, Yellow, Brown, Orange | CL2 | 186 | 41 |
| 55308 | TSTAT 18/8C SOL CU N/S CM/CL2 PVC | 18 | 8 | Brown | Red, White, Green, Blue, Yellow, Brown, Orange, Black | CL2 | 202 | 47 |
| 55310 | TSTAT 18/10C SOL CU N/S CM/CL2 PVC | 18 | 10 | Brown | Red, White, Green, Blue, Yellow, Brown, Orange, Black, Pink, Gray | CL2 | 238 | 58 |
| 55312 | TSTAT 18/12C SOL CU N/S CM/CL2 PVC | 18 | 12 | Brown | Red, White, Green, Blue, Yellow, Brown, Orange, Black, Pink, Gray, Tan, Purple | CL2 | 245 | 69 |
| 55202 | TSTAT 20/2C SOL CU N/S CM/CL2 PVC | 20 | 2 | Brown | Red, White | CL2 | 114 | 9.2 |
| 55203 | TSTAT 20/3C SOL CU N/S CM/CL2 PVC | 20 | 3 | Brown | Red, White, Green | CL2 | 121 | 12.6 |
| 55204 | TSTAT 20/4C SOL CU N/S CM/CL2 PVC | 20 | 4 | Brown | Red, White, Green, Blue | CL2 | 132 | 16.2 |
| 55205 | TSTAT 20/5C SOL CU N/S CM/CL2 PVC | 20 | 5 | Brown | Red, White, Green, Blue, Yellow | CL2 | 147 | 20.1 |
| 55206 | TSTAT 20/6C SOL CU N/S CM/CL2 PVC | 20 | 6 | Brown | Red, White, Green, Blue, Yellow, Brown | CL2 | 160 | 23.7 |
| 55207 | TSTAT 20/7C SOL CU N/S CM/CL2 PVC | 20 | 7 | Brown | Red, White, Green, Blue, Yellow, Brown, Orange | CL2 | 160 | 27 |
| 55208 | TSTAT 20/8C SOL CU N/S CM/CL2 PVC | 20 | 8 | Brown | Red, White, Green, Blue, Yellow, Brown, Orange, Black | CL2 | 142 | 26.1 |
| 55210 | TSTAT 20/10C SOL CU N/S CM/CL2 PVC | 20 | 10 | Brown | Red, White, Green, Blue, Yellow, Brown, Orange, Black, Pink, Gray | CL2 | 202 | 38 |
| 55212 | TSTAT 20/12C SOL CU N/S CM/CL2 PVC | 20 | 12 | Brown | Red, White, Green, Blue, Yellow, Brown, Orange, Black, Pink, Gray, Tan, Purple | CL2 | 209 | 44.3 |

SIMpull THHN® COPPER THHN WIRE & CABLE

SIMpull THHN® COPPER THHN WIRE & CABLE

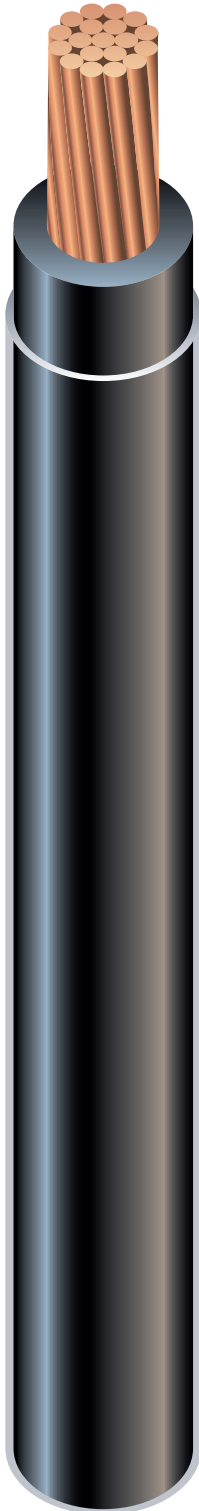

600 Volts. Copper Conductor. Thermoplastic Insulation/Nylon Sheath, Heat, Moisture, Gasoline and Oil Resistant. All Sizes Rated Both THHN and either THWN (sizes 14, 12, and 10 AWG) or THWN-2 (sizes 8 AWG and larger). Also Rated MTW and AWM (See Below). SIMpull® Technology for Easier Pulling.

APPLICATION

Southwire SIMpull THHN® copper conductors are primarily used in conduit and cable trays for services, feeders and branch circuits in commercial or industrial applications as specified in the National Electrical Code. Voltage for all applications is 600 volts. SIMpull THHN® copper conductors are designed to be installed without application of a pulling lubricant.

CONSTRUCTION

Southwire SIMpull THHN® copper conductors are made with soft drawn copper. Sizes 14 through 4/0 AWG use a combination -unilay stranding while 250 kcmil and larger sizes use a compressed copper stranding. The wire is covered with a tough heat and moisture resistant PVC insulation with an overall nylon jacket utilizing SIMpull® Technology. Available in black, white, red, blue, purple, green, yellow, orange, brown, and gray. Also available in striped configurations.



WE'VE GOT IT
MADE IN AMERICA™

PUMP & IRRIGATION WIRE

SIMpull THHN® COPPER THHN WIRE & CABLE

SIMpull THHN® COPPER THHN WIRE & CABLE

| CONDUCTOR | | INSULATION THICKNESS (MILS) | JACKET THICKNESS (MILS) | NOMINAL O.D. (MILS) | APPROX. NET WT. PER 1000' (LBS.) | ALLOWABLE AMPACITIES+ | | | STANDARD PACKAGE |
|---------------------|----------------|-----------------------------|-------------------------|---------------------|----------------------------------|-----------------------|------|------|------------------|
| SIZE (AWG OR KCMIL) | NO. OF STRANDS | | | | | 60°C | 75°C | 90°C | |
| 14* | 1 | 15 | 4 | 102 | 15 | 15 | 15 | 15 | AC |
| 12* | 1 | 15 | 4 | 119 | 23 | 20 | 20 | 20 | AC |
| 10* | 1 | 20 | 4 | 150 | 36 | 30 | 30 | 30 | AC |
| 14* | 19 | 15 | 4 | 109 | 16 | 15 | 15 | 15 | AC |
| 12* | 19 | 15 | 4 | 128 | 24 | 20 | 20 | 20 | AC |
| 10* | 19 | 20 | 4 | 161 | 38 | 30 | 30 | 30 | AC |
| 8 | 19 | 30 | 5 | 213 | 63 | 40 | 50 | 55 | ABCD |
| 6 | 19 | 30 | 5 | 249 | 95 | 55 | 65 | 75 | ABCD |
| 4 | 19 | 40 | 6 | 318 | 152 | 70 | 85 | 100 | ABCD |
| 3 | 19 | 40 | 6 | 346 | 189 | 85 | 100 | 115 | ABCD |
| 2 | 19 | 40 | 7 | 378 | 234 | 95 | 115 | 130 | ABCD |
| 1 | 19 | 50 | 7 | 435 | 299 | 110 | 130 | 145 | ABCD |
| 1/0 | 19 | 50 | 7 | 474 | 372 | 125 | 150 | 170 | ABCD |
| 2/0 | 19 | 50 | 7 | 518 | 462 | 145 | 175 | 195 | ABCD |
| 3/0 | 19 | 50 | 7 | 568 | 575 | 165 | 200 | 225 | ABCD |
| 4/0 | 19 | 50 | 7 | 624 | 718 | 195 | 230 | 260 | ABCD |
| 250 | 37 | 60 | 8 | 694 | 851 | 215 | 255 | 290 | ABCD |
| 300 | 37 | 60 | 8 | 747 | 1012 | 240 | 285 | 320 | ABC |
| 350 | 37 | 60 | 8 | 797 | 1174 | 260 | 310 | 350 | ABC |
| 400 | 37 | 60 | 8 | 842 | 1334 | 280 | 335 | 380 | ABC |
| 500 | 37 | 60 | 8 | 926 | 1655 | 320 | 380 | 430 | ABCD |
| 600 | 61 | 70 | 9 | 1024 | 1987 | 350 | 420 | 475 | ABC |
| 750 | 61 | 70 | 9 | 1126 | 2464 | 400 | 475 | 535 | BC |
| 1000 | 61 | 70 | 9 | 1275 | 3257 | 455 | 545 | 615 | C |

* Sizes 14, 12, and 10 AWG are available with SIMpull® Technology only in SIMpull® Barrel or CoilPAK® configurations. Standard put ups vary from the ones shown on this chart for standard 14-10 AWG THHN.

+Allowable ampacities shown are for general use as specified by the 2014 Edition of the National Electrical Code Sections 310.15 and 240.4(D).

Unless the equipment is marked for use at higher temperatures the conductor shall be limited to the following per NEC 110.14(C):

60° C - When terminated to equipment for circuits rated 100 amperes or less or marked for 14 - 1 AWG conductors.

75° C - When terminated to equipment for circuits rated over 100 amperes or marked for conductors larger than 1 AWG.

90° C - THHN dry locations and THWN-2 wet or dry locations for ampacity adjustment purposes using NEC section 310.15.

Package

Codes:

A - 2500' Reel

B - 1000' Reel

C - 500' Spool

D - 5000' Reel

PUMP & IRRIGATION WIRE

3/C CU 2000V XLPE RHH/RHW-2 PVC VFD POWER CABLE TYPE TC-ER

3/C CU 2000V XLPE RHH/RHW-2 PVC VFD POWER CABLE TYPE TC-ER



WE'VE GOT IT
MADE IN AMERICA™

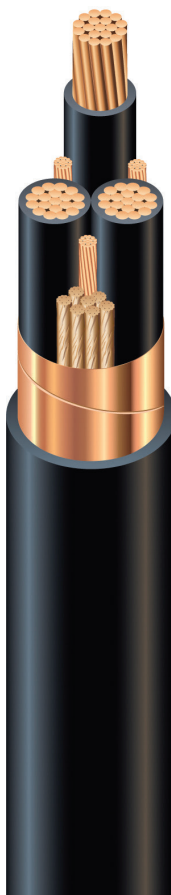

Type TC-ER VFD Power Cable 2000Volt Three Conductor Copper Polyvinyl Chloride (PVC) Jacket with 3 Symmetrical Bare CU Ground 50% Minimum Tape Shield Overlap

CONSTRUCTION

- Conductor: Class B compressed stranded bare copper per ASTM B3 and ASTM B8
- Insulation: Cross Linked Polyethylene (XLPE) Type RHH/RHW-2
- Grounding Conductor: 3 Class B compressed stranded bare copper ground per ASTM B3 and ASTM B8 (ground size is 50% of the phase conductor)
- Filler: Paper filler (cable size 8 & 6 uses Polypropylene filler)
- Binder: Polyester flat thread binder tape for cable sizes larger than 2 AWG
- Tape Shield: 5 mil copper tape shield with a minimum of 50% overlap
- Overall Jacket: Polyvinyl Chloride (PVC) Jacket

APPLICATIONS AND FEATURES

Southwire's 2000 Volt Type TC-ER VFD power cables are suited for use in wet and dry areas, conduits, ducts, troughs, trays, direct burial, aerial supported by a messenger, and where superior electrical properties are desired. These cables are capable of operating continuously at the conductor temperature not in excess of 90°C for normal operation in wet and dry locations, 130°C for emergency overload, and 250°C for short circuit conditions. For uses in Class I, II, and III, Division 2 hazardous locations per NEC Article 501 and 502. Constructions with 3 or more conductors are listed for exposed runs (TC-ER) per NEC 336.10.

SPECIFICATIONS

- ASTM B3 Soft or Annealed Copper
- ASTM B8 Concentric-lay-standard copper
- UL 44 Thermoset Insulated wires And cables
- UL 1277 Electrical Power and Control Cable
- UL 1685 - Flame Test
- UL 1581 - Electrical Wires
- IEEE 1202/FT4 - Vertical Tray Flame Test (70)
- ICEA S-58-679 - Control Cable Conductor Identification Method 4
- ICEA S-95-658 NEMA WC70 - Power cables rated 2000 volts or less for the distribution of electrical energy

| STOCK CODE | COND. SIZE | DIA OVER COND. (1) | INSUL. THICKNESS | DIA OVER COND. (2) | GROUND | JACKET THICKNESS | APPROX. OD (6) | COPPER WEIGHT | APPROX. WEIGHT |
|------------|------------|--------------------|------------------|--------------------|-----------|------------------|----------------|---------------|----------------|
| | AWG | INCHES | INCHES | INCHES | NO. X AWG | MILS | INCHES | LBS./MFT | LBS./MFT |
| 580672 ◊ | 14 | 0.070 | 60 | 0.190 | 3 x 18 | 45 | 0.519 | 54 | 175 |
| 580685 ◊ | 12 | 0.087 | 60 | 0.207 | 3 x 16 | 45 | 0.558 | 85 | 220 |
| 580693 ◊ | 10 | 0.111 | 60 | 0.231 | 3 x 14 | 60 | 0.638 | 136 | 307 |
| 569388 ◊ | 8 | 0.139 | 70 | 0.279 | 3 x 14 | 60 | 0.743 | 193 | 427 |
| 580701 ◊ | 6 | 0.174 | 70 | 0.314 | 3 x 12 | 60 | 0.819 | 307 | 586 |
| 569389 ◊ | 4 | 0.221 | 70 | 0.361 | 3 x 12 | 80 | 0.959 | 452 | 789 |
| 569387 ◊ | 2 | 0.277 | 70 | 0.417 | 3 x 10 | 80 | 1.081 | 718 | 1120 |
| TBA | 1 | 0.321 | 90 | 0.501 | 3 x 8 | 80 | 1.262 | 937 | 1460 |
| 644333 ◊ | 1/0 | 0.360 | 90 | 0.540 | 3 x 6 | 80 | 1.346 | 1233 | 1805 |
| 644334 ◊ | 2/0 | 0.404 | 90 | 0.584 | 3 x 6 | 80 | 1.441 | 1491 | 2121 |
| 644337 | 3/0 | 0.454 | 90 | 0.634 | 3 x 5 | 80 | 1.549 | 1880 | 2577 |
| 644338 ◊ | 4/0 | 0.510 | 90 | 0.690 | 3 x 4 | 80 | 1.670 | 2370 | 3146 |
| 644339 ◊ | 250 | 0.558 | 105 | 0.768 | 3 x 2 | 110 | 1.899 | 2960 | 3978 |
| 644340 ◊ | 350 | 0.661 | 105 | 0.871 | 3 x 2 | 110 | 2.121 | 3896 | 5084 |
| 644341 ◊ | 500 | 0.789 | 105 | 0.999 | 3 x 1 | 110 | 2.398 | 5461 | 6867 |

◊ Cable marked with this symbol is a standard stock item

PUMP & IRRIGATION WIRE

NON-METALLIC FLEXIBLE CONDUIT

ULTRATITE® NON-METALLIC FLEXIBLE CONDUIT, GRAY



CONSTRUCTION

Ultratite Type NM is manufactured with rigid PVC reinforcement imbedded within a flexible PVC wall. The construction provides excellent impact and crush strength while remaining highly flexible. The conduit resists oils, mild acids and exposure to sunlight.

APPLICATION

Ultratite® Liquidtight Flexible Nonmetallic Conduit is suitable for the following installations:

- For the installation and protection of electrical conductors
- Motor circuits - for conductors of motor feeders, branch and control circuits
- Where the conditions of installation, operation, or maintenance require flexibility or protection from liquids, vapors, solids, or weather
- Agricultural buildings per NEC® 547.5
- Used in industrial and commercial applications for conveyors, blowers, cranes, air conditioners, machine tooling and lubrication equipment
- Exposed or concealed installations
- Applications requiring movement, crossover connections, or tight bends
- For direct burial and encased in concrete
- For flexible connections to swimming pool, spa, and hot tub motors per NEC® 680.21(A)(3) & 680.42(A)(1)
- Electric signs and outline lighting supply and secondary-circuit conductors per NEC® 600.7, 600.31 (1000 volts or less) & 600.32 (over 1000 volts)
- Hazardous locations - see Additional Applications Section on the following page for more details



| STOCK # | TRADE SIZE (IN) | INNER DIAMETER (MIN/MAX) | OUTER DIAMETER (MIN/MAX) | NOMINAL TOTAL WEIGHT (LBS/1000') | MIN. BEND RADIUS (IN) |
|---------|-----------------|--------------------------|--------------------------|----------------------------------|-----------------------|
| 550941 | 3/8 | 4.840/5.040 | 0.690/0.710 | 105 | 4 |
| 550942 | 1/2 | 0.622/0.642 | 0.820/0.840 | 129 | 6.5 |
| 550943 | 3/4 | 0.820/0.840 | 1.030/1.050 | 178 | 8.5 |
| 550944 | 1 | 1.041/1.066 | 1.290/1.315 | 259 | 13 |
| 550945 | 1 1/4 | 1.380/1.410 | 1.630/1.660 | 309 | 16 |
| 550946 | 1 1/2 | 1.575/1.600 | 1.865/1.990 | 446 | 18 |
| 550947 | 2 | 2.020/2.045 | 2.340/2.375 | 620 | 22 |

PUMP & IRRIGATION WIRE

ROUGH ELECTRICAL COMPONENTS



NM PLT CONNECTORS

STRAIGHT NM PLT CONNECTORS



FEATURES

- Liquidtight, raintight, oiltight
- For flexible nonmetallic liquidtight tubing
- Easy assembly avoids having to remove the compression nut
- Straight type
- Gray
- Also available in black

APPLICATIONS

For use in wet and dry locations

Standard Material

6/6 Nylon

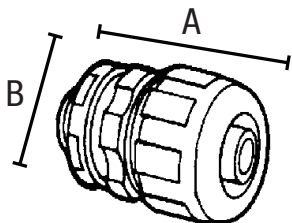

| MODEL # | SIZE | INNER QTY | MASTER QTY | A | B |
|---------|------|-----------|------------|------|------|
| P471 | 1/2" | 25 | 100 | 2.11 | 1.43 |
| P472 | 3/4" | 10 | 100 | 2.20 | 1.68 |
| P473 | 1" | 5 | 50 | 2.28 | 1.99 |

90° NM PLT CONNECTORS



FEATURES

- Liquidtight, raintight, oiltight
- For flexible nonmetallic liquidtight tubing
- Easy assembly avoids having to remove the compression nut
- 90° angle
- Gray
- Also available in black

APPLICATIONS

For use in wet and dry locations

Standard Material

6/6 Nylon

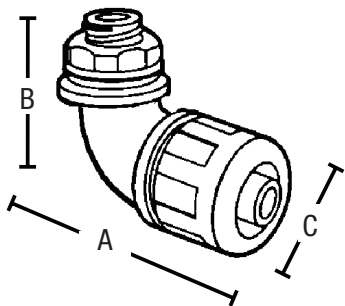

| MODEL # | SIZE | INNER QTY | MASTER QTY | A | B | C |
|---------|------|-----------|------------|------|------|------|
| P491 | 1/2" | 10 | 100 | 2.56 | 2.14 | 1.09 |
| P492 | 3/4" | 10 | 100 | 2.84 | 2.38 | 1.30 |
| P493 | 1" | 5 | 50 | 2.25 | 2.81 | 1.50 |

CABLE TIES

STANDARD AND HEAVY DUTY CABLE TIES



IP21

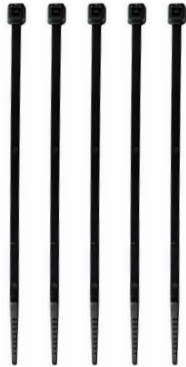

APPLICATION:

- Utility cable ties are designed for use in general applications, while delivering ease of installation, consistent performance, and industry leading reliability.

PRODUCT FEATURES:

- Easy grab tip for pick up from flat surfaces
- Low insertion for quick installation
- Smooth surfaces
- Indoor: Made of nylon 6.6, natural
- Outdoor: Made of nylon 6.6, UV black
- UL Listed

| 50 LBS. SERIES | | | | | | | |
|-----------------|---------|--------|-------|-----------|------------|------|----------|
| PART NUMBER | COLOR | LENGTH | WIDTH | THICKNESS | BNDL. DIA. | PACK | CASE QTY |
| BL7S9-M | Natural | 7.6" | .18" | .054" | 2.0" | 1000 | 10000 |
| BL7S9-C | Natural | 7.6" | .18" | .054" | 2.0" | 100 | 10000 |
| BL7S0-M | Black | 7.6" | .18" | .054" | 2.0" | 1000 | 10000 |
| BL7S0-C | Black | 7.6" | .18" | .054" | 2.0" | 100 | 10000 |
| BL11S9-M | Natural | 11.1" | .18" | .054" | 3.0" | 1000 | 5000 |
| BL11S9-C | Natural | 11.1" | .18" | .054" | 3.0" | 100 | 5000 |
| BL11S0-M | Black | 11.1" | .18" | .054" | 3.0" | 1000 | 5000 |
| BL11S0-C | Black | 11.1" | .18" | .054" | 3.0" | 100 | 5000 |
| BL14S9-M | Natural | 14.6" | .18" | .054" | 4.0" | 1000 | 5000 |
| BL14S9-C | Natural | 14.6" | .18" | .054" | 4.0" | 100 | 5000 |
| BL14S0-M | Black | 14.6" | .18" | .054" | 4.0" | 1000 | 5000 |
| BL14S0-C | Black | 14.6" | .18" | .054" | 4.0" | 100 | 5000 |
| 120 LBS. SERIES | | | | | | | |
| PART NUMBER | COLOR | LENGTH | WIDTH | THICKNESS | BNDL. DIA. | PACK | CASE QTY |
| BL8L9-C | Natural | 9" | .298" | .069" | 2.0" | 100 | 2500 |
| BL8L0-C | Black | 9" | .298" | .069" | 2.0" | 100 | 2500 |
| BL11L9-C | Natural | 12" | .298" | .069" | 3.0" | 100 | 2000 |
| BL11L0-C | Black | 12" | .298" | .069" | 3.0" | 100 | 2000 |
| BL14L9-C | Natural | 14" | .298" | .069" | 4.0" | 100 | 2000 |
| BL14L0-C | Black | 14" | .298" | .069" | 4.0" | 100 | 2000 |
| 175 LBS. SERIES | | | | | | | |
| PART NUMBER | COLOR | LENGTH | WIDTH | THICKNESS | BNDL. DIA. | PACK | CASE QTY |
| BL24H9-L | Natural | 24" | .350" | .087" | 7.2" | 50 | 500 |
| BL24H0-L | Black | 24" | .350" | .087" | 7.2" | 50 | 500 |
| BL36H9-L | Natural | 36" | .350" | .087" | 11.0" | 50 | 500 |
| BL36H0-L | Black | 36" | .350" | .087" | 11.0" | 50 | 500 |
| BL48H9-L | Natural | 48" | .350" | .087" | 15.0" | 50 | 500 |
| BL48H0-L | Black | 48" | .350" | .087" | 15.0" | 50 | 500 |

COMPONENTS | CABLE TIES

HAND TOOLS



MADE IN USA PLIERS

SCP9TPCD-US



DCPA8D-US



Made from American forged steel, these tools are built to withstand jobsite wear and tear. Assembled with hot rivet technology, these pliers are designed to be the livelihood of every professional.

- Hot riveted pivot joint for smooth action
- Induction hardened
- Hand sharpened blades
- Drop forged USA steel for durability

SPECIFICATIONS

| MODEL # | STOCK # | DESCRIPTION | | |
|-------------|----------|--|--------|----------|
| SCP9TPCD-US | 64807340 | Made in USA 9" High-Leverage Side Cutting Pliers w/ Fish Tape Puller, Crimper, & Dipped Grip Handles | | |
| DCPA8D-US | 64807540 | Made in USA 8" Angled Head High-Leverage Diagonal Cutting Pliers w/ Dipped Handles | | |
| CCP9D-US | 64807640 | Made in USA 9" High-Leverage Cable Cutters w/ Dipped Grip Handles | | |
| TCC9D-US | 64807740 | Made in USA 9" Terminal Crimper/Cutter w/ Dipped Grip Handles | | |
| | HEIGHT | WIDTH | DEPTH | WEIGHT |
| SCP9TPCD-US | 11.75" | 3.88" | 11.75" | 1.1 lbs |
| DCPA8D-US | 10.13" | 3.88" | 10.13" | 0.6 lbs |
| CCP9D-US | 11.75" | 3.88" | 11.75" | 1.05 lbs |
| TCC9D-US | 11.75" | 3.88" | 11.75" | 0.9 lbs |

CCP9D-US



TCC9D-US



WE'VE GOT IT

MADE IN AMERICA™

PLIERS

HIGH LEVERAGE SIDE CUTTING PLIERS

SCP9TPCB



Our high leverage side cutting pliers offer a streamlined design with sure-gripping, cross-hatched knurled jaws.

- Induction-hardened cutting blades ensure efficient and lasting cutting surfaces for hard and soft wire
- Drop forged CRV steel for durability
- File teeth on jaws help remove burrs in conduit
- Curved ergonomic handle for comfortable use

SPECIFICATIONS

| MODEL # | STOCK # | DESCRIPTION | HEIGHT | WIDTH | DEPTH | WEIGHT |
|----------|----------|---|--------|-------|-------|----------|
| SCP9TPCB | 65028940 | High Leverage Side Cutting Combo Pliers | | | | |
| SCP9TPCB | | | 9.00" | 3.54" | 0.79" | 1.16 lbs |

MULTI-TOOL PLIERS

S7N1HD



S816SOLHD



This versatile pair of spring action pliers performs multiple functions.

- Grip, strip, crimp, ream, shear, and cut
- Narrow knurled jaw allows access to tight spaces
- Crimps common size wire ferrules
- Reams and smooths thin-wall conduit ends
- Easily strips 10-14 AWG solid wire
- Durable forged construction for lasting performance
- Comfortable grips minimize hand wear and fatigue
- Strips:
 - S7N1HD: 10-14 AWG Solid, 12-16 Stranded
 - S816SOLHD: 8-16 AWG Solid, 10-18 Stranded

SPECIFICATIONS

| MODEL # | STOCK # | DESCRIPTION | HEIGHT | WIDTH | DEPTH | WEIGHT |
|-----------|----------|--|--------|-------|-------|----------|
| S7N1HD | 65028440 | 7-in-1 Long Nose Multi-Tool Pliers | | | | |
| S816SOLHD | 65028140 | Linesman Wire Stripper 8-16 AWG Solid 10-18 AWG Stranded | | | | |
| S7N1HD | | | 10.24" | 3.54" | 0.98" | 0.79 lbs |
| S816SOLHD | | | 10.24" | 3.54" | 0.98" | 0.71 lbs |

LONG NOSE PLIERS

LNP8SD



LNP7D

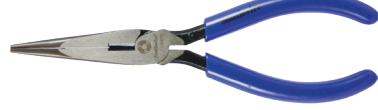

Southwire long nose pliers provide a better grip without sacrificing tool strength or durability.

- Knurled jaws for sure-gripping
- Drop forged CRV steel for durability
- High leverage, hot rivet design for smooth action and no handle wobble
- Long nose design for forming and looping wire and handling small parts
- Precision induction-hardened cutting knives for long-lasting cutting edge
- 12 AWG solid wire stripper on LNP8SD

SPECIFICATIONS

| MODEL # | STOCK # | DESCRIPTION | HEIGHT | WIDTH | DEPTH | WEIGHT |
|---------|----------|---|--------|-------|-------|----------|
| LNP8SD | 58289740 | 8" Hvy. Dty. Long Nose Pliers Side Cutting Stripper Dipped Handle | | | | |
| LNP7D | 58749040 | 7" Long Nose Pliers w/ Side Cut Dipped Handle | | | | |
| LNP8SD | | | 8.38" | 2.13" | 0.63" | 0.64 lbs |
| LNP7D | | | 7.38" | 2.13" | 0.63" | 0.38 lbs |

WIRE STRIPPERS

WIRE STRIPPERS & CUTTERS

S1018SOL



S612STR



S1018STR



S1626STR



Made of stainless steel, these wire strippers have precision ground stripping holes and are fitted with comfortable double-dipped plastic grips.

- Stainless steel construction is durable and rust-proof
- Serrated nose grasps the cable for easy twisting and pulling
- Double-dipped grip provides comfortable feel
- Spring loaded for self-opening action
- Specially designed cutting blades provide fast and clean wire stripping and cutting

SPECIFICATIONS

| MODEL # | STOCK # | DESCRIPTION | | |
|----------|----------|---|-------|----------|
| S1018SOL | 58278040 | Wire Stripper Cutter 10-18SOL;12-20 Stranded Ergonomic Handle | | |
| S1018STR | 58278140 | Compact Stripper Cutter 10-18 AWG Solid | | |
| S612STR | 58277940 | Wire Stripper Cutter 6-12 AWG Stranded Ergonomic Handle | | |
| S1626STR | 58278240 | Compact Stripper Cutter 16-26 AWG Stranded | | |
| | HEIGHT | WIDTH | DEPTH | WEIGHT |
| S1018SOL | 7.63" | 8.38" | 0.69" | 0.33 lbs |
| S1018STR | 6.25" | 2.38" | 0.69" | 0.29 lbs |
| S612STR | 7.38" | 2.5" | 0.63" | 0.33 lbs |
| S1626STR | 6.25" | 2" | 0.69" | 0.28 lbs |

CUTTERS

HAND TOOLS | CUTTERS

CABLE CUTTING PLIERS

CCP9



CCP9DE



CCPR400



CCP350



CCPR400S



The shear type hook jaws grab and hold cable while the shear cutting action allows for clean cuts.

- Heat treated, precision ground blades ensure clean cuts
- Comfortable cushion grips reduce hand fatigue
- Forged steel with black-oxide finish for long life
- High leverage pivot joint ensures smooth action and no handle wobble

SPECIFICATIONS

COMFORT GRIP

| MODEL # | STOCK # | DESCRIPTION | | |
|----------|----------|--------------------------------|-------|----------|
| CCP9 | 58993540 | 9" High Leverage Cable Cutters | | |
| CCPR400 | 58277740 | 750MCM Ratcheting Cable Cutter | | |
| CCP350 | 59158540 | 350MCM 16" Cable Cutter | | |
| CCPR400S | 59556240 | 600MCM Ratcheting Cable Cutter | | |
| | HEIGHT | WIDTH | DEPTH | WEIGHT |
| CCP9 | 9.38" | 2.13" | 0.63" | 0.94 lbs |
| CCPR400 | 13.78" | 6.81" | 1.57" | 0.51 lbs |
| CCP350 | 18.90" | 4.53" | 1.18" | 2.55 lbs |
| CCPR400S | 9.25" | 5.71" | 1.57" | 1.54 lbs |

DIPPED GRIP

| MODEL # | STOCK # | DESCRIPTION | | |
|---------|----------|---|-------|----------|
| CCP9DE | 64323040 | 9" High Leverage Cable Cutters w/ Ergonomic Dipped Handle | | |
| CCP6D | 58748940 | 6 1/2" Cable Cutting Shears w/ Dipped Handle | | |
| | HEIGHT | WIDTH | DEPTH | WEIGHT |
| CCP9DE | 9.25" | 1.8" | 0.62" | 1 lbs |
| CCP6D | 6.75" | 2" | 0.75" | 0.51 lbs |



400A AC CLAMP METER

21510N



The Southwire 21510N 400A AC Clamp Meter offers the features needed for routine electrical repairs. In addition to measuring AC current up to 400A, the 21510N measures AC and DC voltage up to 600V plus provides common multimeter functions such as resistance, capacitance, continuity, temperature and diode. The 21510N offers a built-in, non-contact AC Voltage Detector and a powerful LED worklight for working in dimly lit areas. The 21510N also features a third-hand test probe holder for added convenience. This CAT III clamp meter is designed to survive a 6-foot drop, making it built to last. Great for basic electrical work.

- 400A AC current range
- CAT III 600V safety rating
- Built-in non-contact voltage tester
- Third-Hand test probe holder

SPECIFICATIONS

| MODEL # | STOCK # | DESCRIPTION | | | |
|---------|---------|--|-------|-------|----------|
| 21510N | 650315 | 400A AC Clamp Meter with Built-In NCV, Worklight, and Third-Hand Test Probe Holder | | | |
| | | HEIGHT | WIDTH | DEPTH | WEIGHT |
| 21510N | | 8.48" | 2.91" | 1.4" | 0.6 lbs. |

400A AC/DC CLAMP METER WITH TRUE RMS

21550T



The Southwire 21550T 400A AC/DC Clamp Meter with True RMS offers the features needed for the professional electrician including True RMS accuracy, the ability to measure both AC and DC current, and a built-in, non-contact, AC voltage detector. Other features included are REL and max/min functions in addition to standard multimeter functions such as resistance, capacitance, continuity, temperature, and diode. This clamp meter also has a third-hand test probe holder and a bright LED worklight. The 21550T is built-to-last and is guaranteed to survive a 6-foot drop.

- 400A AC/DC current range
- CAT III 600V safety rating
- True RMS accuracy
- Built-in non-contact voltage tester
- Third-Hand test probe holder

SPECIFICATIONS

| MODEL # | STOCK # | DESCRIPTION | | | |
|---------|---------|---|-------|-------|----------|
| 21550T | 650318 | 400A AC/DC Clamp Meter with True RMS, Built-In NCV, Worklight, and Third-Hand Test Probe Holder | | | |
| | | HEIGHT | WIDTH | DEPTH | WEIGHT |
| 21550T | | 8.48" | 2.91" | 1.4" | 0.6 lbs. |

MULTIMETERS

RESIDENTIALPRO™ BLUETOOTH® CAT III MULTIMETER

14070T



This Bluetooth enabled multimeter in combination with Southwire's MApp™ mobile app allows you to view, record, and share readings on your smartphone. With TrueRMS and Low-Z readings, a rugged waterproof and dust-proof housing, and built-in flashlight, this compact multimeter can be used in a wide range of applications.

- Features automatic power off
- Bluetooth interface for viewing, recording and sharing using Southwire's MApp™ mobile app
- TrueRMS readings provide higher accuracy on AC circuits
- Low-Z function eliminates false readings from "ghost" voltage
- Powerful LED work light for added convenience
- Rugged IP67 waterproof and dust-tight housing
- CAT III 600V safety rating, UL listed
- Built-in test lead storage
- Includes
 - Test leads
 - Type K temperature probe with banana plug adapter
 - Three AAA batteries

SPECIFICATIONS

| MODEL # | STOCK # | DESCRIPTION | |
|--------------------|-------------------------------|---|------------------------------|
| 13090T | 630160 | ResidentialPRO™ Bluetooth® CAT III Multimeter | |
| FUNCTION | RANGE | MAX. RESOLUTION | MAX. ACCURACY (% OF READING) |
| AC Voltage | 600V | 1mV | ±1.0% |
| Low-Z (AC Voltage) | 300V | 1mV | ±1.5% |
| DC Voltage | 600V | 0.1mV | ±1.0% |
| Low-Z (DC Voltage) | 300V | 0.1mV | ±1.5% |
| AC Current | 10A | 0.1µA | ±2.5% |
| DC Current | 10A | 0.1µA | ±2.0% |
| Resistance | 40MΩ | 0.1Ω | ±1.5% |
| Capacitance | 4000µF | 10pF | ±3.0% |
| Frequency | 10kHz | 0.001Hz | ±1.0% |
| Duty Cycle | 1.0 to 99.9% | 0.1% | ±1.2% |
| Temperature | 0°F to 1400°F | 0.1° | ±2.0% |
| | -18°C to 760°C | 0.1° | ±2.0% |
| Continuity | Audible threshold approx. 50Ω | | |
| Diode Test | Yes | | |
| Dimensions | 5.8 x 2.7 x 2.0 in. | | |
| Weight | 0.70 lb. | | |

TEMPORARY LIGHTING



WORK LIGHTS

RECHARGEABLE LED FOLDING WORK LIGHT



514125

- Integrated lithium-ion battery - 7.4V, 800 mAh
- IP65, indoor or outdoor use
- 50,000 hour LED life
- Operating temperature: -10° to 125° F
- 5000K light temperature

SPECIFICATIONS



| MODEL # | DESCRIPTION | ACCESSORIES | LUMENS | WATTS | RUN TIME | RECHARGE TIME |
|---------|----------------------------------|---------------------------------------|---|-------|---|---------------|
| 514124 | PROLIGHT™ Folding LED Work Light | Wall Charger Car Charger | 2,400 LM - High 1,200 LM - Med 800 LM - Low | 30W | 2.5 Hrs - High 5 Hrs. - Medium 8 Hrs. - Low | 4 Hrs. |
| 514125 | PROLIGHT™ Folding LED Work Light | Wall Charger Car Charger Tripod | | | | |

PROLIGHT™ MAX 20W LED WORK LIGHT



511512

- 1,800 lumens
- 110° pivoting head
- Three modes: high, low and strobe
- 20 Watt
- Up to 10 hours run time from 1000 to 1800 lm
- IP65 Rated
- Lithium-ion Rechargeable battery
- Multiple mounting options and magnetic feet

SPECIFICATIONS



| MODEL # | DESCRIPTION | HEIGHT | WIDTH | LENGTH | WEIGHT |
|---------|---------------------------------|--------|-------|--------|--------|
| 511512 | Mini 20W LED Rechargeable Flood | 7" | 12" | 6" | 3" |

20K LUMEN DUAL HEAD



CSW10X2

- Includes: 2-Step Tripod Stand
- Quick-Release Dual Head Base
- On/Off Switch
- 18/3 SJTW Cord
- 5000K Color Temperature
- Each head delivers 10000 lumens

SPECIFICATIONS



| MODEL # | DESCRIPTION | HEIGHT | WIDTH | LENGTH | WEIGHT |
|---------|---|--------|-------|--------|--------|
| CSW10X2 | 20,000 Lumen Dual Head Work Light with Tripod | 24" | 16" | 68" | 14.9" |

5K LUMEN RATCHETING HEADLAMPS



CSW5X1

- Multi-Position Ratcheting Floor Stand
- 360-Degree Rotating Head
- On/Off Switch
- 18/3 SJTW Cord
- 5000K Color Temperature
- 5000 Lumens

SPECIFICATIONS

| MODEL # | DESCRIPTION | HEIGHT | WIDTH | LENGTH | WEIGHT |
|---------|---|--------|-------|--------|--------|
| CSW10X2 | 20,000 Lumen Dual Head Work Light with Tripod | 24" | 16" | 68" | 14.9" |

HANDHELD LIGHTS

ALKALINE BATTERY HEAD LAMP



HL1030SW

- Foam forehead pad
- Adjustable elastic head band
- Smooth dimming
- Hinged aimable head
- 2 x AAA batteries included



SPECIFICATIONS

| MODEL # | DESCRIPTION | SPOT LIGHT LUMENS | FLOOD LIGHT LUMENS | RUN TIME | BATTERIES INCLUDED |
|----------|---|-------------------|------------------------|----------------|--------------------|
| HL1030SW | 300 Lumen LED Adjustable Headlamp with (2x) AAA | 120 | 300 - High 30 - Low | Up to 30 Hours | 2 x AAA Batteries |

RECHARGEABLE HEAD LAMPS



HL12RSW

- Detachable magnetic light head
- Constant current - maintains light level throughout the life of the charge
- IP65 - weatherproof
- 3-Year warranty
- Lithium-ion battery
- HL25RSW has a hands-free on/off sensor and down light for near field tasks like reading
- Includes two hard hat clips and charger



SPECIFICATIONS



HL25RSW

| MODEL # | DESCRIPTION | DOWN LIGHT LUMENS | SPOT LIGHT LUMENS | FLOOD LIGHT LUMENS | RUN TIME | RECHARGE TIME |
|---------|--------------------------------------|------------------------|-------------------|------------------------|---------------|---------------|
| HL12RSW | 120 Lumen Rechargeable LED Head Lamp | N/A | N/A | 120 - High 60 - Low | Up to 5 Hours | 2-3 Hours |
| HL25RSW | 250 Lumen Rechargeable LED Head Lamp | 120 - High 60 - Low | 150 | 250 - High 75 - Low | Up to 8 Hours | 2-3 Hours |

SL SERIES RECHARGEABLE HANDHELD LIGHTS



SL20RSW
SL50RSW

- Magnetic base
- Hanging Hook
- Articulating Arm
- Spot Light Tip
- 1M Drop Test
- Includes carrying case
- Constant current - maintains light level throughout the life of the charge
- 3-Year Warranty
- Lithium-Ion Battery



SPECIFICATIONS

| MODEL # | DESCRIPTION | SPOT LIGHT LUMENS | FLOOD LIGHT LUMENS | RUN TIME | CHARGER INCLUDED |
|---------|---|-------------------|-------------------------|------------------|------------------|
| SL20RSW | 200 Lumen Rechargeable Folding LED Handheld Light | 100 | 200 - High 50 - Low | Up to 10 Hours | Yes |
| SL50RSW | 500 Lumen Rechargeable Folding LED Handheld Light | 100 | 500 - High 100 - Low | Up to 12.5 Hours | Yes |

LIGHTING | HANDHELD LIGHTS

EXTENSION CORDS

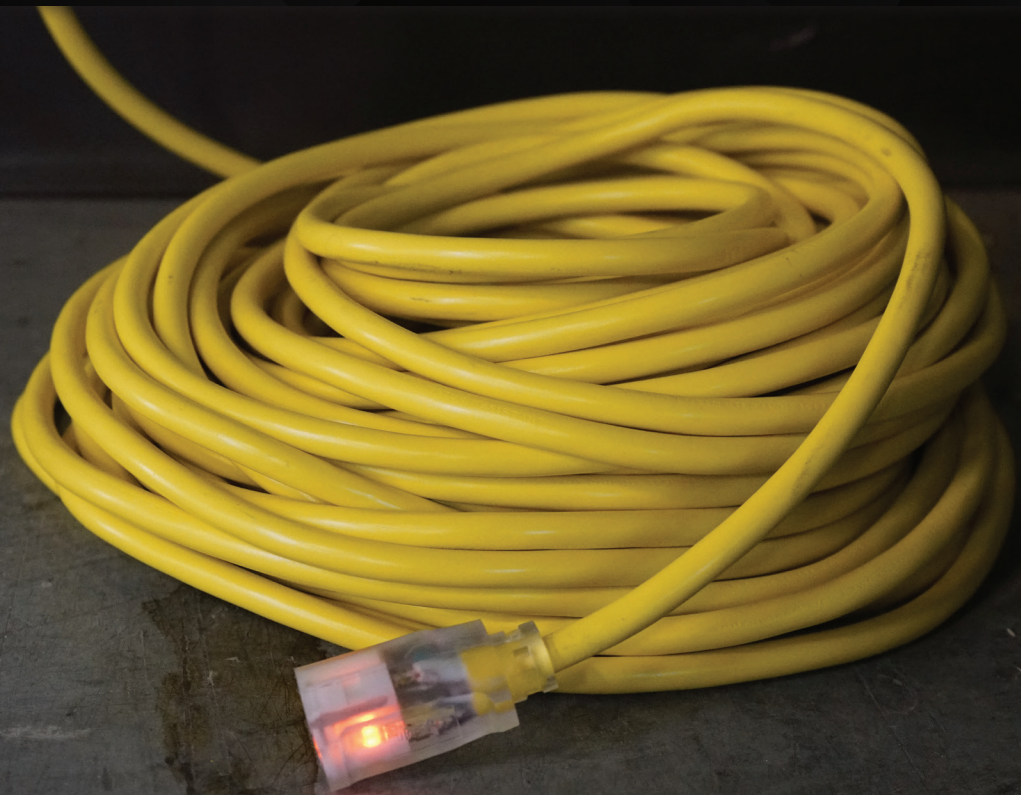

EXTENSION CORDS

12/3 SJEOW COLD SUPREME EXTENSION CORDS WITH LIGHTED ENDS

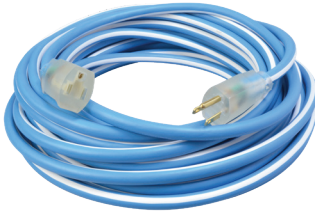

FEATURES

- 15 Amps
- 125 Volts
- UL Rated Temp: -70°C to 105°C
- NEMA 5-15 Plug/Receptacle
- SJEOW Jacket
- Highly Resistant to Abrasion
- Heavy Duty
- Chemical & Oil Resistant Outer Jacket
- Lighted Receptacle Shows Power is On
- Limited Lifetime Warranty

| STOCK # | DESCRIPTION | HEIGHT | WIDTH | DEPTH | WEIGHT | COLOR | GAUGE | AMPS | VOLTAGE | LENGTH |
|------------|--|--------|--------|-------|-----------|------------|-------|------|---------|---------|
| 1638SW0061 | 12/3 50' SJEOW BLUE/WHITE COLD SUPREME EXTENSION CORD W/LIGHTED END | 13" | 5" | 3" | 6.04 lbs | Blue/White | 12/3 | 15 | 125 | 50 ft. |
| 1639SW0061 | 12/3 100' SJEOW BLUE/WHITE COLD SUPREME EXTENSION CORD W/LIGHTED END | 12.5" | 12.25" | 5" | 12.53 lbs | Blue/White | 12/3 | 15 | 125 | 100 ft. |

12/3 SJE00W POLAR/SOLAR EXTENSION CORDS WITH LIGHTED ENDS

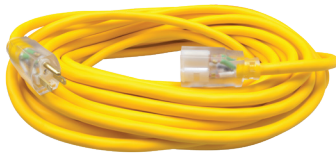

FEATURES

- 15 Amps
- 125 Volts
- UL Rated Temp: -50°C to 60°C
- NEMA 5-15 Plug/Receptacle
- SJE00W Jacket
- Highly Resistant to Abrasion
- Heavy Duty
- Chemical & Oil Resistant
- Lighted Receptacle Shows Power is On
- Limited Lifetime Warranty

| STOCK # | DESCRIPTION | HEIGHT | WIDTH | DEPTH | WEIGHT | COLOR | GAUGE | AMPS | VOLTAGE | LENGTH |
|------------|--|--------|--------|-------|-----------|--------|-------|------|---------|---------|
| 1688SW0002 | 12/3 50' SJE00W YELLOW POLAR/SOLAR EXTENSION CORD W/LIGHTED END | 13" | 5" | 3" | 6.04 lbs | Yellow | 12/3 | 15 | 125 | 50 ft. |
| 1689SW0002 | 12/3 100' SJE00W YELLOW POLAR/SOLAR EXTENSION CORD W/LIGHTED END | 12.5" | 12.25" | 5" | 12.25 lbs | Yellow | 12/3 | 15 | 125 | 100 ft. |

14/3 SJE00W POLAR/SOLAR EXTENSION CORDS WITH LIGHTED ENDS



FEATURES

- 15 Amps
- 125 Volts
- UL Rated Temp: -50°C to 60°C
- NEMA 5-15 Plug/Receptacle
- SJEOW Jacket
- Highly Resistant to Abrasion
- Medium Duty
- Chemical & Oil Resistant
- Lighted Receptacle Shows Power is On
- Limited Lifetime Warranty

| STOCK # | DESCRIPTION | HEIGHT | WIDTH | DEPTH | WEIGHT | COLOR | GAUGE | AMPS | VOLTAGE | LENGTH |
|------------|---|--------|-------|-------|----------|--------|-------|------|---------|---------|
| 1488SW0002 | 14/3 50' SJE00W YELLOW POLAR/SOLAR EXTENSION CORD W/LIGHTED END | 14" | 5.75" | 3" | 4.42 lbs | Yellow | 14/3 | 15 | 125 | 50 ft. |
| 1489SW0002 | 14/3 100' SJE00W POLAR/SOLAR EXTENSION CORD W/LIGHTED END | 15" | 7.5" | 3" | 8.09 lbs | Yellow | 14/3 | 13 | 125 | 100 ft. |

EXTENSION CORDS

EXTENSION CORDS

14/3 SJTW LOW TEMP EXTENSION CORDS WITH LIGHTED ENDS

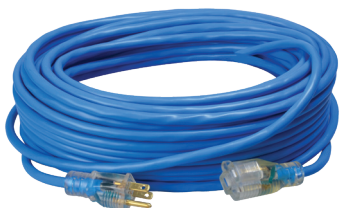

FEATURES

- 15 Amps
- 125 Volts
- UL Rated Temp: -50°C to 60°C
- NEMA 5-15 Plug/Receptacle
- Low Temp SJTW Jacket
- Low Temp Outdoor Cord
- Medium Duty
- Weather Resistant Jacket
- Lighted Receptacle Shows Power is On
- Limited Lifetime Warranty

| STOCK # | DESCRIPTION | HEIGHT | WIDTH | DEPTH | WEIGHT | COLOR | GAUGE | AMPS | VOLTAGE | LENGTH |
|------------|--|--------|-------|-------|----------|-------|-------|------|---------|---------|
| 2468SW8806 | 14/3 50' SJTW LOW TEMP BLUE EXTENSION CORD W/LIGHTED END | 13.5" | 2.5" | 7" | 4.81 lbs | Blue | 14/3 | 15 | 125 | 50 ft. |
| 2469SW8806 | 14/3 100' SJTW LOW TEMP BLUE EXTENSION CORD W/LIG | 14" | 3" | 7" | 9.55 lbs | Blue | 14/3 | 13 | 125 | 100 ft. |

12/3 SJTW MADE IN USA EXTENSION CORDS WITH LIGHTED ENDS



FEATURES

- 15 Amps
- 125 Volts
- UL Rated Temp: -40°C to 60°C
- NEMA 5-15 Plug/Receptacle
- SJTW Jacket
- Weather Resistant Jacket
- Heavy Duty
- Rated for Outdoors
- Lighted Receptacle Shows Power is On
- Limited Lifetime Warranty



**WE'VE GOT IT
MADE IN AMERICA™**

| STOCK # | DESCRIPTION | HEIGHT | WIDTH | DEPTH | WEIGHT | COLOR | GAUGE | AMPS | VOLTAGE | LENGTH |
|------------|--|--------|-------|-------|-----------|----------------|-------|------|---------|--------|
| 2548SWUSA1 | 12/3 50' SJTW MADE IN USA RED/WHITE/BLUE W/LIGHTED ENDS | 14" | 7.5" | 3" | 6.42 lbs | Red/White/Blue | 3-Dec | 15 | 125 | 50 ft. |
| 2549SWUSA1 | 12/3 100' SJTW MADE IN USA RED/WHITE/BLUE W/LIGHTED ENDS | 15" | 10" | 3.5" | 12.56 lbs | Red/White/Blue | 3-Dec | 15 | 125 | 50 ft. |

12/3 SJTW TRI-SOURCE EXTENSION CORDS WITH LIGHTED ENDS



FEATURES

- 15 Amps
- 125 Volts
- UL Rated Temp: -40°C to 60°C
- NEMA 5-15 Plug/Receptacle
- SJTW Jacket
- Weather Resistant Jacket
- Heavy Duty
- Rated for Outdoors
- Lighted Receptacle Shows Power is On
- Limited Lifetime Warranty

| STOCK # | DESCRIPTION | HEIGHT | WIDTH | DEPTH | WEIGHT | COLOR | GAUGE | AMPS | VOLTAGE | LENGTH |
|------------|---|--------|-------|-------|-----------|--------|-------|------|---------|---------|
| 4188SW8802 | 12/3 50' SJTW TRI-SOURCE YELLOW EXTENSION CORD W/LIGHTED END | 13" | 3" | 7.5" | 7.87 lbs | Yellow | 3-Dec | 15 | 125 | 50 ft. |
| 4189SW8802 | 12/3 100' SJTW YELLOW TRI-SOURCE EXTENSION CORD W/LIGHTED END | 13" | 3" | 10.5" | 14.88 lbs | Yellow | 3-Dec | 15 | 125 | 100 ft. |

EXTENSION CORDS

PIGTAILS – POWER SUPPLY CORD SPT-3 STRAIGHT AND RIGHT ANGLE



Rated 125 Volt

APPLICATION

Southwire's SPT-3 Power Supply Cords (pigtails) can be used for general purpose use. For multiple uses and suitable for a replacement power cord for air conditioners, refrigerators, freezers, microwaves

CONSTRUCTION

- Southwire's SPT-3 Power Supply Cords (pigtails) are manufactured using bare flexible stranded copper conductors with grey PVC insulation
- Available with a straight plug or right angle plug. The other end will be split and stripped

SPECIFICATIONS:

- UL Listed (UL 817)
- NEMA 5-15P

| STOCK # | DESCRIPTION | AWG | #COND | CORD LENGTH (FT) | VOLTS | AMPS | WATT |
|------------|--|-----|-------|------------------|-------|------|------|
| 9724SW8809 | REPLCORD, 16/3 SPT-3 R/ANGLE 4' GRAY SW | 16 | 3 | 4 | 125 | 13A | 1625 |
| 9726SW8809 | REPLCORD, 16/3 SPT-3 R/ANGLE 6' GRAY SW | 16 | 3 | 6 | 125 | 13A | 1625 |
| 9733SW8809 | REPLCORD, 16/3 SPT-3 STRAIGHT 3' GRAY SW | 16 | 3 | 3 | 125 | 13A | 1625 |
| 9734SW8809 | REPLCORD, 16/3 SPT-3 STRAIGHT 4' GRAY SW | 16 | 3 | 4 | 125 | 13A | 1625 |
| 9736SW8809 | REPLCORD, 16/3 SPT-3 STRAIGHT 6' GRAY SW | 16 | 3 | 6 | 125 | 13A | 1625 |

16/3 6' SJTW POWER SUPPLY CORD

9706SW8808



FEATURES

- 13 Amps
- 125 Volts
- SJTW Jacket
- UL Rated Temp: -40°C to 60°C
- Power Supply Replacement Cord
- Black
- NEMA 5-15 Plug
- Light Duty

| STOCK # | DESCRIPTION | HEIGHT | WIDTH | DEPTH | WEIGHT | COLOR | GAUGE | AMPS | VOLTAGE | LENGTH |
|------------|--------------------------------|--------|-------|-------|----------|-------|-------|------|---------|--------|
| 9706SW8808 | 16/3 6' SJTW POWER SUPPLY CORD | 12" | 0.75" | 3" | 0.44 lbs | Black | 16/3 | 13 | 125 | 6 ft. |

14/3 6' SJTW POWER SUPPLY CORD

9716SW8808



FEATURES

- 15 Amps
- 125 Volts
- SJTW Jacket
- UL Rated Temp: -40°C to 60°C
- Power Supply Replacement Cord
- Black
- NEMA 5-15 Plug
- Medium Duty

| STOCK # | DESCRIPTION | HEIGHT | WIDTH | DEPTH | WEIGHT | COLOR | GAUGE | AMPS | VOLTAGE | LENGTH |
|------------|--------------------------------|--------|-------|-------|----------|-------|-------|------|---------|--------|
| 9716SW8808 | 14/3 6' SJTW POWER SUPPLY CORD | 11.75" | 0.75" | 3" | 0.66 lbs | Black | 14/3 | 15 | 125 | 6 ft |

EXTENSION CORDS

NOTES

NOTES



Southwire™

PUMP & IRRIGATION CATALOG

get social with us:



[/SOUTHWIRETOOLS](#)



[/SOUTHWIRE-COMPANY](#)



[@SOUTHWIRETOOLS](#)



[@SOUTHWIRE](#)



SCAN TO LEARN MORE

WWW.SOUTHWIRE.COM | 1-855-SWTTOOLS

All Trademarks or Registered Trademarks (TM/®) are owned or licensed by Southwire Company.
Any other TM/®- Trademark or Registered Trademark of Southwire Company.