



Southwire™

ELECTRONIC SOLUTIONS CATALOG



**BUILT FOR DURABILITY.
BUILT FOR RELIABILITY.
BUILT FOR WORK.™**

SOUTHWIRE.COM

OUR STORY

As a family business, Southwire® proudly continues building on our commitment to environmental stewardship and corporate sustainability by prioritizing stakeholder expectations, and supporting the wellbeing of our communities and the environment in which we live. To help us meet this commitment, we organize our sustainability strategy around five core tenets: Growing Green, Living Well, Giving Back, Doing Right, and Building Worth.

We Deliver Power...Responsibly®

We remain committed to the sustainability of our company for the next 100 years and beyond. As we strengthen this commitment, we continue to work hard every day to discover, develop and distribute sustainable solutions that exceed the expectations of our stakeholders around the world.

OUR MISSION

To be a **preferred provider** of solutions to the electrical industry by providing innovative products and services with exceptional quality.

OUR VALUES

Our **ONE Southwire** culture prioritizes the interests of our team members, customers, and communities through a continuous commitment to empowerment, trust, consistency, and inclusion.

OUR REACH

Nearly one in two new homes built in the United States contains our wire, and we produce half of the cable used to transmit and distribute electricity throughout the nation.

OUR PRODUCTS

Our product teams and dedicated resources work together to listen to and work with our customers, creating solutions that deliver unparalleled value through product innovation, safety and efficiency.

OUR SERVICE

Service is more than a word or a phone number; it's a tangible support system that assists you through the entire project cycle; from our knowledgeable customer service team, to our experienced field sales team, we're there every step of the way.



TABLE OF CONTENTS

OVERVOLTAGE PROTECTION

RV Surge Protection.....	5
Surge Guard* - Portable	8-10
Surge Guard* - Hardwired	11
Surge Guard* - Accessories.....	12

POWER DELIVERY

RV Automatic Transfer Switches (ATS).....	14
Basic RV ATS.....	15
Limited RV ATS.....	15
RVC Full Protection ATS	16
RV ATS Accessories	16
RV Battery Control Centers	17
RV Reels.....	18
Shoreline - Electric Reels	18
Shoreline - Water Reels	19
Shoreline - Accessories.....	19
Portable Power Stations	20
Elite Series.....	20
Power Strips	21

GROUND FAULT CIRCUIT INTERRUPTERS (GFCI)

GFCI & ELCI	23
Shockshield™ - Adapters and Cord Sets	24-28
Shockshield™ - User Attachables & Panel Mounts	29
HD Pro - High Power GFCI ELCI.....	30
Wiring Instructions.....	30

COMPLIANCE

Definitions & Standards.....	32
NEMA Configurations.....	33
OSHA Regulations.....	34

OVERVOLTAGE PROTECTION

Poor power quality entering your RV can not only affect the longevity of your electronic equipment and motors, but can cost you thousands of dollars in repairs and create frustrating, unnecessary travel delays. Surge protection in and around the home is commonplace in today's world. Surges, however, are not the only dangers to your electronic equipment. The quality of power entering a home is generally consistent; however, the same cannot be said for RV parks.

Power quality in RV parks is subject to vast fluctuations and is dependent upon many factors. Intensity of electrical loads placed on an RV park, weather conditions, faulty wiring, and undersized or deteriorating electrical connections affect the quality of power entering your RV. With today's RV containing sophisticated and sensitive electronics, a few short seconds of faulty power can damage equipment within the coach, such as inverters, converters, microwaves, TV's, and refrigerators.



SURGE GUARD* TECHNOLOGY

FROM PEDESTAL TO PANEL

Poor power quality entering your RV can not only affect the longevity of your electronic equipment and motors, but can cost you thousands of dollars in repairs and create frustrating, unnecessary travel delays. Electrical fires can lead to costly damage and/or complete loss of the RV, expensive insurance claims, and inconvenient downtime.

90% OF ALL RV'S *DO NOT HAVE ANY* FORM OF ELECTRICAL PROTECTION



PROTECT AGAINST THE DANGERS OF ELECTRICAL FIRES.

ELECTRICAL ISSUES DAMAGING RVS

POWER SURGES

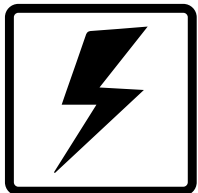

FIRE / DAMAGE TO RV
ELECTRONICS & APPLIANCES

OVERHEATING



MELTED WIRES AND PLUGS
ELECTRICAL FIRES

OPEN GROUND/
OPEN NEUTRAL



DANGEROUS / FATAL SHOCK
DAMAGE TO ELECTRONICS

MISWIRED
PEDESTAL

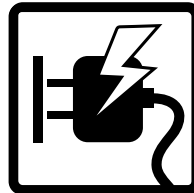

ELECTRICAL SHOCK / FIRE
DAMAGE TO ELECTRONICS

LOW / HIGH
VOLTAGE



OVERHEATING CIRCUIT
BOARDS DAMAGE TO
ELECTRONICS/APPLIANCES









WE HAVE YOU COVERED

SURGE GUARD* | TECHNOLOGY

OVERVOLTAGE PROTECTION

SURGE GUARD* SURGE PROTECTION COMPARISON

SELECT THE LEVEL OF PROTECTION THAT YOUR RV NEEDS	SURGE		SURGE+			
	30A Portable 44260	50A Portable 44270	30A Portable 44280	50A Portable 44290	30A Portable 44380	50A Portable 44390
						
Over I Under Voltage (Input)						
Open Neutral Protection (Input)						
Open Ground Protection						
Overheating Plug I Receptacle Protection			Indicates	Indicates	Indicates	Indicates
Reverse Polarity Protection (Input)						
Elevated Ground Protection						
Surge Failure Indication	●	●	●	●	●	●
Miswired Pedestal Indication	●	●	●	●	●	●
Time Delay at Power Up						
Optional Remote LCD Display						
Over I Under Frequency Protection						
Weather Resistant	●	●	●	●	●	●
UL Listed					●	●
Source Power Connection Diagnostics	●	●	●	●	●	●
Lock Hasp Available	●	●				
Surge Suppression (Joules)	2,100	4,200	2,100	4,200	2,100	4,200
Max Spike Current (Per MOV)	6,500A	6,500A	6,500A	6,500A	6,500A	6,500A

SURGE GUARD* | COMPARISON CHART

OVERVOLTAGE PROTECTION

SURGE GUARD* SURGE PROTECTION COMPARISON

SELECT THE LEVEL OF PROTECTION THAT YOUR RV NEEDS	FULL PROTECTION					
	30A Portable 34930	50A Portable 34950	30A Portable 34931	50A Portable 34951	30A Portable 35530	50A Portable 35550
Over Under Voltage (Input)	●	●	●	●	●	●
Open Neutral Protection (Input)	●	●	●	●	●	●
Open Ground Protection	●	●	●	●	●	●
Overheating Plug Receptacle Protection	●	●	●	●		
Reverse Polarity Protection (Input)	●	●	●	●	●	●
Input & Output Open Neutral Protection	●	●	●	●		
Surge Failure Indication	●	●	●	●	●	●
Miswired Pedestal Indication	●	●	●	●	●	●
Time Delay at Power Up	10 sec.	10 sec.	10 sec.	10 sec.	128 sec.	128 sec.
Compatible with Surge Guard* iOS and Android apps.			●	●		
Optional Remote LCD Display			40301	40301	40300	40300
Over Under Frequency Protection	●	●	●	●		
Weather Resistant	●	●	●	●		
UL Listed					●	●
Source Power Connection Diagnostics	●	●	●	●	●	●
Lock Hasp Available						
Surge Suppression (Joules)	2,450	4,200	2,450	4,200	2,450	3,850
Max Spike Current (Per MOV)	6,500A	6,500A	6,500A	6,500A	6,500A	6,500A

SURGE GUARD* | COMPARISON CHART

OVERVOLTAGE PROTECTION

SURGE GUARD* 30A & 50A BASIC



44260

44270



Perfect for pop-ups and travel trailers.

- Identifies faulty park power plus offers surge protection
- Analyzes circuits to verify pedestal wiring
- Tests for and indicates:
 - Open ground
 - Open neutral
 - Correct polarity
- Easy-T-Pull™ handles
- Compatible with Surge Guard* Lock Hasp model 34590



MODEL #	VOLTAGE	AMPS	SURGE SUPPRESSION	LOCK RING INCLUDED
44260	120V	30A	2,100J	No
44270	240V	50A	4,200J	No

SURGE GUARD* | PORTABLE

OVERVOLTAGE PROTECTION

SURGE GUARD* 30A & 50A SURGE+



44280

44290



Perfect for pop-ups and travel trailers.

- Automatically shuts off the power when equipment identifies faulty park power and provides surge protection
- Increased receptacle brass thickness reduces heat
- Easy-T-Pull™ handle with integrated receptacle
- Tests for and indicates:
 - Open ground
 - Open neutral
 - Correct polarity
 - Open circuit/no power
 - Missing leg 1/leg 2 voltage *50A only*
 - Surge protection status
 - Overheating plug/receptacle



44380

44390

MODEL #	VOLTAGE	AMPS	SURGE SUPPRESSION	LOCK RING INCLUDED	cULus LISTED
44280	120V	30A	2,100J	No	No
44290	240V	50A	4,200J	No	No
44380	120V	30A	2,100J	Yes	Yes
44390	240V	50A	4,200J	Yes	Yes



44280

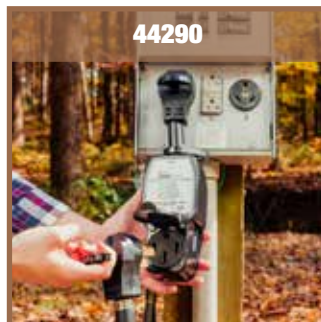

44290

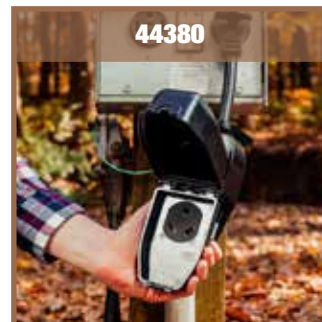

44380

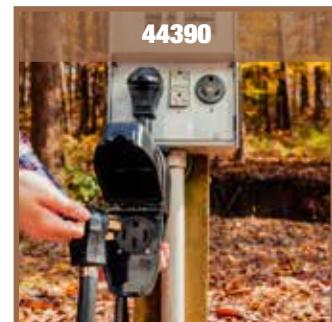

44390

SURGE GUARD* | PORTABLE

OVERVOLTAGE PROTECTION

SURGE GUARD* 30A & 50A FULL PROTECTION



34930

34950



RV Side Electrical Protection: Total electrical protection from faulty park power and electrical issues inside the RV.

- Provides Protection Against:
 - Power surges
 - Open ground
 - Open neutral
 - Low (<102V) / High (>132V) voltage
 - Overheating plug/receptacle
 - Continuously monitors for and displays:
 - Voltage and Amp Draw (RMS)
 - Reverse polarity
 - Miswired pedestal
 - High neutral current (50A model)
- Elevated ground line current
- Patented - RV side open neutral protection (50A only)
- Automatic reset on power restoration
- 10 second start up sequence
- 128 second reset delay protects A/C compressor
- Easy-T-Pull™ handles



WORKS WITH SURGE GUARD*
IOS AND ANDROID APPS



34931

34951



MODEL #	VOLTAGE	AMPS	SURGE SUPPRESSION	LOCK RING INCLUDED	OPTIONAL REMOTE COMPATIBLE
34930	120V	30A	2,450J	Yes	No
34950	240V	50A	4,200J	Yes	No
34931	120V	30A	2,450J	Yes	Yes
34951	240V	50A	4,200J	Yes	Yes



40301

OPTIONAL ACCESSORY	
40301	Surge Guard*, Wireless Display

The Bluetooth® word mark and logos are registered trademarks of Bluetooth® SIG, Inc. and any use of such marks by Southwire Company, LLC is under license. Apple and the Apple logo are trademarks of Apple, Inc., registered in the U.S. and other countries. App Store is a service mark of Apple, Inc.



34930



34950



34931

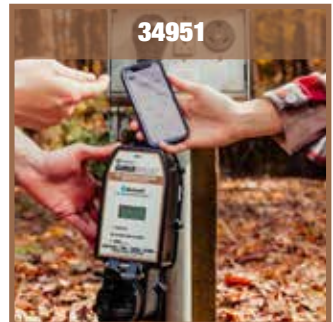

34951

SURGE GUARD* | PORTABLE

OVERVOLTAGE PROTECTION

SURGE GUARD* 30A & 50A FULL PROTECTION



35530



35550



Total electrical protection from faulty park power.

- Provides Protection Against:
 - Power surges
 - Open ground
 - Open neutral
 - Low (<102V) / High (>132V) voltage
 - Overheating plug/receptacle
 - Voltage and Amp Draw (RMS)
 - Surge failure
 - Reverse polarity
 - Miswired pedestal
 - High neutral current (50A model)
 - Continuously monitors for and indicates:
 - Automatic reset on power restoration
 - 128 second reset delay protects A/C compressor



MODEL #	VOLTAGE	AMPS	SURGE SUPPRESSION
35530	120V	30A	2,450J
35550	240V	50A	3,850J



40300

OPTIONAL ACCESSORY	
40300	Surge Guard*, Remote Display

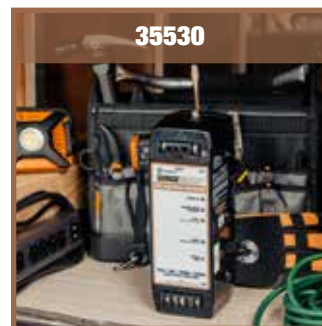

35530

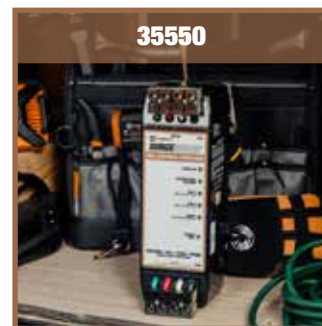

35550

SURGE GUARD* | HARDWIRED

OVERVOLTAGE PROTECTION

SURGE GUARD* LOCK HASP



34590-001



- Designed to prevent unauthorized removal of your Surge Guard* electrical protector from your RV
- Fits all portable Surge Guard* models and Surge Guard* Voltage Regulators
- Easily attaches to standard 30A & 50A plugs
- Not compatible with Surge Guard* models 44280, 44290, 34930, 34931, 34950, and 34951

SURGE GUARD* GENERATOR NEUTRAL-GROUND BONDING PLUG



44400

- Designed to detect an open ground condition and not allow power to pass through
- Compatible with 15A receptacle on the generator control panel
- Creates a neutral-to-ground bond to resolve open ground condition
- Check owner's manual of the generator to ensure the generator was designed with a floating neutral

POWER DELIVERY







Products developed to deliver power to the RV market. Even reliable sources of power can sometimes be lost, and your heating, air conditioning, and other necessary camping accessories will be dead. Automatic Transfer Switches allow switching to a backup source of power such as a generator if the main source of power is lost.

Bulky main power cables can be messy and hard to manage. Use our self-spooling cable reels to make storage of cables and connecting to power sources a breeze. We also offer reels for water hoses to connect to portable water sources.



POWER DELIVERY

SURGE GUARD* AUTOMATIC TRANSFER SWITCHES COMPARISON

SELECT THE LEVEL OF PROTECTION YOUR RV NEEDS	BASIC		LIMITED	FULL PROTECTION		
	30A Basic ATS 41300	50A Basic ATS 40100	50A Limited Protection 41261	50A Full Protection 40350-RVC	50A Full Protection 40450-RVC	90A Full Protection 41390-RVC
						
Over/Under Voltage (Input)				●	●	●
Open Neutral Protection (Input)			●	●	●	●
Reverse Polarity Protection (Input)			●	●	●	●
Miswired Pedestal Indication				●	●	●
Open Ground Protection				●	●	●
Time Delay at Power Up (3-4 sec.)	●	●	●	●	●	●
Remote Display (P/N 40299)				Optional	Optional	Optional
Current (Amps) Measurement				●	●	●
Source Power Connection Diagnostics				●	●	●
Generator Dominant	●	●	●	●	●	●
Mechanical Interlocking Contractors		●	●	●	●	●
Proprietary Electrical Interlock	●					
Surge Suppression (Joules)	N/A	N/A	2,600	3,350	3,350	3,350
Max Spike Current	N/A	N/A	76,400A	130,000A	130,000A	130,000A
Contractor Rating	30A, FLA	50A, FLA	50A, FLA	65A, FLA	65A, FLA	95A, FLA
Safety Certified Standard	UL 1008	UL 1008	UL 1008	UL 1008	UL 1008	UL 1008

POWER DELIVERY | COMPARISON CHART

POWER DELIVERY

SURGE GUARD* BASIC AUTOMATIC TRANSFER SWITCHES



41300-100

Transfers to generator power automatically when energized after 30 second delay. When both shore power and generator power are available, generator dominates after a 30 second delay. Once the generator is shut down, shore power activates after a 3-4 second delay.

- 30A Model 41300 has proprietary electrical interlock
- 50A Model 40100 has mechanical interlocking contactors
- Time delay at power up
- Dual contactor arrangement
- Does NOT provide surge protection
- UL approved - UL1008 full transfer switch rating



MODEL #	VOLTAGE	AMPS	SURGE SUPPRESSION
41300-100	120V	30A	---
40100-001	120V/240V	50A	---
40140-001	120V/240V	50A	---

SURGE GUARD* LIMITED AUTOMATIC TRANSFER SWITCHES



41301

This unit transfers to either shore power or generator power automatically when energized. In the event both shore and generator powers are available, generator power will dominate after a 30 second delay.

- Provides open ground and reverse polarity protection
- Limited protection from faulty park power
- Provides protection against:
 - Power surges
 - Open neutral
 - Reverse polarity
- Multi-mode surge suppression
- 50A, FLA mechanical interlocking contactors



MODEL #	VOLTAGE	AMPS	SURGE SUPPRESSION
41301	120V	30A	---
40141-001	120V/240V	50A	---
40101-001	120V/240V	50A	---
41261-011	120V/240V	50A	2,600J

POWER DELIVERY | TRANSFER SWITCHES

POWER DELIVERY

SURGE GUARD* RVC FULL PROTECTION AUTOMATIC TRANSFER SWITCH



40430RVC1

These units transfers to generator power automatically when energized after 30 second delay (generator mode). When both shore and generator power are available, generator dominates after 30 second delay. Once generator shuts down, shore power activates after a 3 second delay.

- Total electrical protection from faulty park power
- Provides protection against:
 - Power surges
 - Open ground
 - Open neutral
 - Low (<102V) / High (>132V) voltage
 - Reverse polarity
 - Miswired pedestal
 - High / low frequency
- RVC communication allows instant display of voltage, current and fault conditions on RVC compatible device
- Voltage and current (continuously monitored and indicated)

MODEL #	VOLTAGE	AMPS	SURGE SUPPRESSION	cULus LISTED	OPTIONAL REMOTE COMPATIBLE
41390RVC	120/240V	90A	3,350J	Yes	Yes
40350RVC3	120/240V	50A	3,350J	Yes	Yes
40450RVC3	120/240V	50A	3,350J	Yes	No
40430RVC1	120V	30A	2,450J	No	Yes

OPTIONAL ACCESSORY	
40258	Modular Cord Assy,(RJ-12),Remote, 50'
40299	Surge Guard*, Remote Display, RV Power

POWER DELIVERY

RV BATTERY CONTROL CENTERS



55-0200



55-0300

- Nominal voltage: 12VDC
- Operating temperature: -40°F to 165°F
- Nominal current per disconnect relay: 260A

MODEL #	INTERNAL DISCONNECT RELAYS	FUEL TYPE
55-0200	3	Gasoline
55-0300	2	Diesel

POWER DELIVERY | CONTROL CENTERS

POWER DELIVERY

SHORELINE REELS™ - ELECTRIC



RH54331RMK

- Eliminates tangled and kinked cords
- Non-stiffening, super-flexible power cords
- Quiet operation
- No remote controls necessary
- Hardwired into coach
- Spool sides and core are anodized aluminum
- Side frames powder coated galvanized steel
- Available with or without 4' pigtail that attaches the reel to the transfer switch or junction box



MODEL #	PROFILE	AMPS	CONDUCTOR COUNT	CORD LENGTH	PIGTAIL LENGTH	HANDLE SIDE	RETRACT METHOD
RH54330RM	High	50A	4	33'	Lugs	Right	Motorized
RH54331RM	High	50A	4	33'	4'	Right	Motorized
RH54331RMK	High	50A	4	33'	4'	Right	Motorized
RH54361RM	High	50A	4	36'	4'	Right	Motorized
RL54330LM	Low	50A	4	33'	Lugs	Left	Motorized
RL54360LM	Low	50A	4	36'	Lugs	Left	Motorized
PT33250RM	Pedestal	30A	3	25'	Lugs	Right	Motorized

SHORELINE | REELS



RH54331LMK



POWER DELIVERY

SHORELINE REELS™ RV DRINKING WATER HOSE REEL - RW SERIES



- Powered in by drive motor
- Listed for portable water applications
- Output to coach is 0.5' MPT
- 40' of 0.5" portable water drinking water hose
- IAPMO approved to NSF standards kink-free drinking safe water hose



MODEL #	CORD LENGTH	HANDLE SIDE	RETRACT METHOD
RW40RM	40'	Right	Motorized
RW40RMK	40'	Right	Motorized

SHORELINE REELS™ RV MACERATING HOSE REEL - RB SERIES



- Powered in by drive motor
- Easy connection to RV macerator pumps
- Ball valve eliminates caps and plugs
- 20' of 0.75" non-collapsible hose



MODEL #	CORD LENGTH	HANDLE SIDE	RETRACT METHOD
RB17RM	17'	Right	Motorized
RB20LM	20'	Left	Motorized
RB20RM	20'	Right	Motorized
RB20RMK	20'	Right	Motorized

SHORELINE REELS™ ACCESSORIES



RV2050

MODEL #	DESCRIPTION
RV2021	Kit, Switch Rocker 3 x 3 Box
RV2050	TRC, Round Hatch & Roller Kit
RV2057	Thru-Wall Roller Guide
RV2059	TRC, Square Roller Guide
RV2061	TRC, Square Hatch & Roller (4" x 5")
RV2075	Rectangular Hatch, 6.5" x 11.5"
RV2100	RV Boxed Switch Kit
RV3100	RV Box Switch (Back Drive)
RV3200	RV Boxed Switch In-Line Kit

POWER DELIVERY

ELITE SERIES™ PORTABLE POWER STATIONS



53253

Southwire Elite Series™ Portable Power Stations offer a wide variety of on-the-go power solutions. The lightweight design and solar generated power allows electronics to stay charged. Featuring 6-ways to charge and a high contrast LCD display, Southwire Elite Series™ Portable Power Stations allow you to have power wherever, whenever.

- Industry Best! 6 Ways to Charge - car DC outlet, solar panel, wall outlet, USB power delivery, PD + AC, or with a generator
- Runs a 32" led tv for more than 4 hours
- Built-in LED light with SOS function
- Charges from 0 to 100% in as little as 2 hrs
- High contrast LCD screen with multiple readouts
- Includes Bonus: 8-in-1 DC adapter set
- In the box: 72W AC adapter, DC car adapter, instruction manual
- 2 year warranty



MODEL #	DESCRIPTION	ITEM HEIGHT	ITEM LENGTH/DEPTH	ITEM WEIGHT (LBS.)	ITEM WIDTH
53250	Portable Pwr Stn 200 w/ AC & DC Adapts	7.5	8.5	6.6	6.3
53251	Portable Pwr Stn 300 w/ AC & DC Adapts	7.5	8.5	7.7	6.3
53252	Portable Pwr Stn 500 w/ AC & DC Adapts	7.9	10.2	11	6.8
53253	Portable Pwr Stn 1100 w/ AC & DC Adapts	8.1	13.2	24.6	9.1
53224	100W Solar Pnl Quad-Fold Case w/ Cords	1.18	13.78	7.67	17.72
53252K	Pwr Station 500 & 100W Solar Panel Kit	7.9	10.2	11	6.8



ELITE SERIES | POWER STATIONS

POWER DELIVERY

20 AMP METAL POWER STRIP



5120

Southwire 20A Metal Power Strips work with Southwire 1970 Series X-Treme Box™, Jobsite Generators, and all NEMA 5-20 Receptacles.

- Cold rolled steel maintains housing structure
- Black color matches Southwire carts and boxes
- Keyhole slots on bottom for mounting
- Mounting template included
- 5-20 Receptacles also allow 15 amp plugs



MODEL #	ELECTRICAL RATING			CORD LENGTH	CORD GAUGE	# OF OUTLETS	USB COUNT	PLUG & RECEPTACLE TYPE
5120	125V	20A	2500W	6'	12/3 AWG	6	0	NEMA 5-20
5122	125V	20A	2500W	15'	12/3 AWG	6	0	NEMA 5-20

MAGNETIC POWER STRIP



5126

Southwire Magnetic Power Strips are sure to be an attractive solution on the jobsite. Stick them to a metal surface and the 25+ pounds of pull force will hold in place with cords plugged in. Enhance jobsite safety by keeping electrical connections off the floor. Perfect for use with metal studs, tool boxes, I-beams, and more.

- Illuminated On/Off switch
- Integrated Cord management
- 25 Pounds of magnetic force
- Cord clip plug
- Indoor use only



MODEL #	ELECTRICAL RATING			CORD LENGTH	CORD GAUGE	# OF OUTLETS	USB COUNT	PLUG & RECEPTACLE TYPE
5126	125V	20A	1875W	6'	14/3 AWG	6	0	NEMA 5-15
5127	125V	20A	1875W	8'	14/3 AWG	5	2 USB-A	NEMA 5-15

POWER STRIPS | METAL & MAGNETIC

GFCI GROUND FAULT CIRCUIT INTERRUPTERS

Southwire has an extensive line of electrical safety products that ensures protection from dangerous current leakage that can cause electrical shock and possible electrocution. Our patented technologies enable you to protect people, property and equipment.



GFCI & ELCI

WHAT IT IS AND HOW IT WORKS

GFCI

GFCI's (Ground Fault Circuit Interrupters) monitor the balance of electrical current moving through a circuit. A GFCI prevents fatal electrical shocks by promptly cutting off the flow of electricity if power goes where it shouldn't, like in a short. The National Electric Code and OSHA requires the use of GFCI's in many applications and use cases.

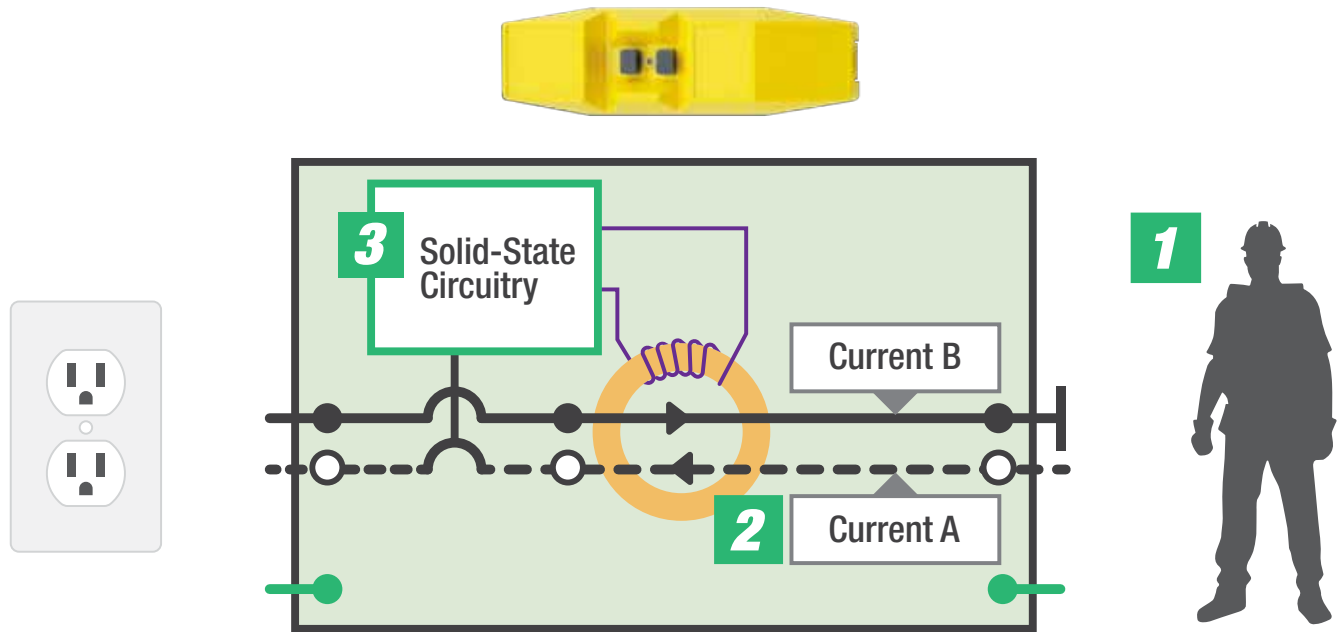







1. Current travels through the body
2. Current transformer picks up on current imbalance (current A \neq to current B)
3. Circuitry opens circuit when current imbalance detected

ELCI

ELCI's (Equipment Leakage Current Interrupters) monitor the balance of electrical current moving through a circuit. An ELCI prevents equipment damage by promptly cutting off the flow of electricity if power goes where it shouldn't, like in a short. Many individuals install ELCI's to protect their investments.

GFCI & ELCI

GFCI PORTABLES

MODEL #	GFCI TYPE	ELECTRICAL RATING			CORD LENGTH	CORD GAUGE	WIRE TYPE	CORD COLOR	RECEPTACLE COUNT	LIGHTED RECEPTACLE	PLUG & RECEPTACLE TYPE
14650006-6	Right Angle	120V	15A	60Hz	N/A	N/A	N/A	White	Single	No	
14650013-6	Right Angle	120V	15A	60Hz	N/A	N/A	N/A	Yellow	Single	No	
14650032-6	Right Angle	120V	15A	60Hz	N/A	N/A	N/A	Black	Single	No	
14880024-3	Right Angle	120V	15A	60Hz	6'	14/3 AWG	SJTW	Yellow	Single	No	
14880023-6	Right Angle	120V	15A	60Hz	2'	12/3 AWG	SJTW	Yellow	Triple	Yes	
14880004-6	Right Angle	120V	15A	60Hz	6'	12/3 AWG	SJTW	Yellow	Triple	No	
14880119-1	Right Angle	120V	15A	60Hz	50'	12/3 AWG	SJTW	Yellow	Triple	No	
14880120-1	Right Angle	120V	15A	60Hz	99'	12/3 AWG	SJTW	Yellow	Triple	No	
14880228-6	Right Angle	120V	15A	60Hz	25'	12/3 AWG	SJEOW	Yellow	Triple	No	
14880229-6	Right Angle	120V	15A	60Hz	50'	12/3 AWG	SJEOW	Yellow	Triple	No	
14880230-4	Right Angle	120V	15A	60Hz	100'	12/3 AWG	SJEOW	Yellow	Triple	No	
26020002-6	In-Line	120V	15A	60Hz	2'	14/3 AWG	SJTW	Yellow	Single	No	
26020121-6	In-Line	120V	15A	60Hz	2'	14/3 AWG	SJTW	Yellow	Single	Yes	
26020050-1	In-Line	120V	15A	60Hz	50'	14/3 AWG	SJTW	Yellow	Single	No	
26020011-6	In-Line	120V	15A	60Hz	2'	12/3 AWG	SJTW	Yellow	Single	No	
26020150-1	In-Line	120V	15A	60Hz	50'	12/3 AWG	SJTW	Yellow	Single	No	
26020008-6	In-Line	120V	15A	60Hz	2'	12/3 AWG	SJTW	Yellow	Triple	Yes	
26020148-1	In-Line	120V	15A	60Hz	50'	12/3 AWG	SJTW	Yellow	Triple	No	
30040008-6	In-Line	120V	15A	60Hz	2.5'	12/3 AWG	SEOW	Yellow	Triple	No	
25080011-6	In-Line	120V	20A	60Hz	2'	12/3 AWG	SJTW	Yellow	Single	No	
25080301-6	In-Line	120V	20A to 15A	60Hz	2'	12/3 AWG	STW	Yellow	Single	No	
26000011-6	In-Line	240V	20A	60Hz	2'	12/3 AWG	SJTW	Yellow	Single	No	
26000016-3	In-Line	240V	20A	60Hz	6'	12/3 AWG	SJTOW	Yellow	Single	No	
44830004-3	In-Line	120V	30A	60Hz	2'	10/3 AWG	SJ00W	Yellow	Single	No	
44830005-2	In-Line	120V	30A	60Hz	6'	10/3 AWG	SJ00W	Yellow	Single	No	
44800012-3	In-Line	240V	30A	60Hz	3'	10/3 AWG	SJ00W	Yellow	Single	No	
44800013-2	In-Line	240V	30A	60Hz	6'	10/3 AWG	SJ00W	Yellow	Single	No	
44800020-1	In-Line	240V	30A	60Hz	25'	10/3 AWG	SJ00W	Yellow	Single	No	
14880003-3	Right Angle	120V	15A	60Hz	6'	12/3 AWG	SJTW/ SJTOW	Yellow	Quad	No	
28438802	In-Line	120V	15A	60Hz	6'	12/3 AWG	SJTW	Yellow	Double	No	

GFCI & ELCI

USER ATTACHABLES AND PANEL MOUNTS

MODEL #	GFCI TYPE	ELECTRICAL RATING			CORD GAUGE	ENCLOSURE COLOR	TRIP LEVEL
25230001-6	User Attachable	120V	20A	60Hz	Accepts 18 - 12 AWG (SJT) (12 AWG JR cords)	Yellow	4-6 mA
26000200-6	User Attachable	240V	20A	60Hz	Accepts 18 - 12 AWG (SJT) (12 AWG JR cords)	Yellow	4-6 mA
26140010-6	User Attachable	120V	20A	60Hz	Accepts 18 - 12 AWG (SJT)	Black	30 mA
	User Attachable	240V	16A	60Hz			
25040101-3	User Attachable	120V	20A	60Hz	Accepts 18 - 12 AWG (SJT)	Black	10 mA
	User Attachable	240V	16A	60Hz			
14880002-6	User Attachable	120V	15A	60Hz	Accepts 18 - 12 AWG (SJT)	Yellow	4-6 mA
14880232-6	User Attachable	120V	15A	60Hz	Accepts 18 - 12 AWG (SJT)	Black	4-6 mA
32360001-3	Panel Mount	120V	20A	60Hz	L & N - 12 AWG	Black	4-6 mA
24220100-3	Panel Mount	120V	20A	50/60Hz	Accepts 250V female quick disconnect terminals	Black	10 mA Typical

HIGH POWER GFCI | ELCI

MODEL #	PROTECTION TYPE	ELECTRICAL RATING			GAUGE	ENCLOSURE COLOR	TRIP LEVEL	
24520001-1	ELCI	120V	60A	60Hz	1 ϕ	4/3 AWG	Grey	10 mA
24500006-1	ELCI	208-240V	30A	60Hz	3 ϕ	10/4 AWG	Black	10 mA
24140002-1	ELCI	240V	30A	60Hz	1 ϕ	10/4 AWG	Black	10 mA
24530001-1	ELCI	240V	60A	60Hz	3 ϕ	4/4 AWG	Grey	10 mA
25560001-1	ELCI	380V	60A	60Hz	3 ϕ	4/4 AWG	Grey	30 mA
24846001-1	GFCI ELCI	208-240V	30A	60Hz	3 ϕ	8/5 AWG	Grey	6, 10, & 30 mA
24542001-1	GFCI ELCI	208-240V	60A	60Hz	3 ϕ	4/4 AWG	Grey	6, 10, & 30 mA
24786001-1	GFCI ELCI	208-240V	80A	60Hz	3 ϕ	4/4 AWG	Grey	6, 10, & 30 mA
24646001-1	GFCI ELCI	480V	30A	60Hz	3 ϕ	10/4 AWG	Grey	6, 10, & 30 mA
24672001-1	GFCI ELCI	480V	60A	60Hz	3 ϕ	4/4 AWG	Grey	6, 10, & 30 mA
24796001-1	GFCI ELCI	480V	80A	60Hz	3 ϕ	4/4 AWG	Grey	6, 10, & 30 mA

GFCI & ELCI | CONFIGURATIONS

GFCI & ELCI

15A SINGLE OUTLET RIGHT ANGLE ADAPTERS



14650006-6

Provides GFCI and single mode surge protection with any appliance or tool used indoors.

- GFCI with 4-6mA trip point
- 25mS trip response time
- Manual reset
- Provides compliance with NEC 2008 Article 590.6 for Temporary Installations
- Small Size (less than 3" high and 2" wide) make it perfect for the toolbox
- Applications: Institutional and residential



MODEL #	ELECTRICAL RATING			COLOR	RECEPTACLE COUNT	PLUG & RECEPTACLE TYPE
14650006-6	120V	15A	60Hz	White	Single	 NEMA 5-15
14650013-6	120V	15A	60Hz	Yellow	Single	
14650032-6	120V	15A	60Hz	Black	Single	

SHOCKSHIELD™ | ADAPTERS & CORD SETS

15A RIGHT ANGLE CORD SETS



14880024-3

Shockshield™ Right Angle GFCI ensures protection from dangerous current leakage that can cause electrical shock and possible electrocution.

- GFCI with 4-6mA trip point
- 25mS trip response time
- Manual reset
- Provides compliance with NEC 2008 Article 590.6 for Temporary Installations
- Custom cable gauges, lengths and terminations available by special order
- Applications: Plant maintenance, equipment service and construction sites



MODEL #	ELECTRICAL RATING			CORD LENGTH	CORD GAUGE	WIRE TYPE	CORD COLOR	RECEPTACLE COUNT	LIGHTED RECEPTACLE	PLUG & RECEPTACLE TYPE
14880024-3	120V	15A	60Hz	6'	14/3 AWG	SJTW	Yellow	Single	No	 NEMA 5-15
14880023-6	120V	15A	60Hz	2'	12/3 AWG	SJTW	Yellow	Triple	Yes	
14880004-6	120V	15A	60Hz	6'	12/3 AWG	SJTW	Yellow	Triple	No	
14880119-1	120V	15A	60Hz	50'	12/3 AWG	SJTW	Yellow	Triple	No	
14880120-1	120V	15A	60Hz	99'	12/3 AWG	SJTW	Yellow	Triple	No	
14880228-6	120V	15A	60Hz	25'	12/3 AWG	SJEOW	Yellow	Triple	No	
14880229-6	120V	15A	60Hz	50'	12/3 AWG	SJEOW	Yellow	Triple	No	
14880230-4	120V	15A	60Hz	100'	12/3 AWG	SJEOW	Yellow	Triple	No	

GFCI & ELCI

15A | 20A IN-LINE CORD SETS



26020008-6

Shockshield™ In-Line GFCI ensures protection from dangerous current leakage that can cause electrical shock and possible electrocution.

- GFCI with 4-6mA trip point
- 25mS trip response time
- Manual reset
- Provides compliance with NEC 2008 Article 590.6 for Temporary Installations
- Custom cable gauges, lengths and terminations available by special order
- Applications: Plant maintenance, equipment service, and construction sites



MODEL #	ELECTRICAL RATING			CORD LENGTH	CORD GAUGE	WIRE TYPE	CORD COLOR	RECEPTACLE COUNT	LIGHTED RECEPTACLE	PLUG & RECEPTACLE TYPE
26020002-6	120V	15A	60Hz	2'	14/3 AWG	SJTW	Yellow	Single	No	 NEMA 5-15
26020121-6	120V	15A	60Hz	2'	14/3 AWG	SJTW	Yellow	Single	Yes	
26020050-1	120V	15A	60Hz	50'	14/3 AWG	SJTW	Yellow	Single	No	
26020011-6	120V	15A	60Hz	2'	12/3 AWG	SJTW	Yellow	Single	No	
26020150-1	120V	15A	60Hz	50'	12/3 AWG	SJTW	Yellow	Single	No	
26020008-6	120V	15A	60Hz	2'	12/3 AWG	SJTW	Yellow	Triple	Yes	
26020148-1	120V	15A	60Hz	50'	12/3 AWG	SJTW	Yellow	Triple	No	
30040008-6	120V	15A	60Hz	2.5'	12/3 AWG	SEOW	Yellow	Triple	No	
25080011-6	120V	20A	60Hz	2'	12/3 AWG	SJTW	Yellow	Single	No	 NEMA 5-20
25080301-6	120V	20A to 15A	60Hz	2'	12/3 AWG	STW	Yellow	Single	No	 NEMA 5-15R NEMA L5-20P
26000011-6	240V	20A	60Hz	2'	12/3 AWG	SJTW	Yellow	Single	No	 NEMA 6-20
26000016-3	240V	20A	60Hz	6'	12/3 AWG	SJTOW	Yellow	Single	No	

SHOCKSHIELD™ | CORD SETS

GFCI & ELCI

30A | 40A IN-LINE CORD SETS



44830004-3

Shockshield™ In-Line GFCI ensures protection from dangerous current leakage that can cause electrical shock and possible electrocution.

- GFCI with 4-6mA trip point
- 25mS trip response time
- Manual reset
- Provides compliance with NEC 2008 Article 590.6 for Temporary Installations
- Custom cable gauges, lengths and terminations available by special order
- Applications: Plant maintenance, equipment service, and construction sites



MODEL #	ELECTRICAL RATING			CORD LENGTH	CORD GAUGE	WIRE TYPE	CORD COLOR	RECEPTACLE COUNT	LIGHTED RECEPTACLE	PLUG & RECEPTACLE TYPE
44830004-3	120V	30A	60Hz	2'	10/3 AWG	SJ00W	Yellow	Single	No	 NEMA L5-30
44830005-2	120V	30A	60Hz	6'	10/3 AWG	SJ00W	Yellow	Single	No	
44800012-3	240V	30A	60Hz	3'	10/3 AWG	SJ00W	Yellow	Single	No	 NEMA L6-30
44800013-2	240V	30A	60Hz	6'	10/3 AWG	SJ00W	Yellow	Single	No	
44800020-1	240V	30A	60Hz	25'	10/3 AWG	SJ00W	Yellow	Single	No	

15A BOXES WITH CORD SETS



28438802

Shockshield™ GFCI boxes are built to withstand outdoor/rugged-type construction.

- GFCI with 4-6mA trip point
- 25mS trip response time
- Manual reset
- Provides compliance with NEC 2008 Article 590.6 for Temporary Installations
- Spring loaded covers protect receptacles
- Applications: Plant maintenance, equipment service, and construction sites



MODEL #	ELECTRICAL RATING			CORD LENGTH	CORD GAUGE	WIRE TYPE	CORD COLOR	RECEPTACLE COUNT	GFCI TYPE	PLUG & RECEPTACLE TYPE
14880003-3	120V	15A	60Hz	6'	12/3 AWG	SJTW/SJTOW	Yellow	Quad	Right-Angle	 NEMA 5-15
28438802	120V	15A	60Hz	6'	12/3 AWG	SJTW	Yellow	Double	In-Line	

SHOCKSHIELD™ | ADAPTERS & CORD SETS

GFCI & ELCI

15A | 16A | 20A USER ATTACHABLES



25040101-3



25230001-6

Shockshield™ In-Line user attachable for OEM connection of cable.

- Trip point up to 30mA
- Less than 25mS trip response time
- Manual reset
- Can be easily attached by connecting the GFCI in series with the supply cable 9 to 10 inches from the plug end to provide GFCI protection
- Applications: OEM / custom cord set

MODEL #	ELECTRICAL RATING			CORD GAUGE	ENCLOSURE COLOR	TRIP LEVEL	GFCI TYPE	COMPLIANCE
25230001-6	120V	20A	60Hz	Accepts 18 - 12 AWG (SJT) (12 AWG JR cords)	Yellow	4-6mA	In-Line	cULus
26000200-6	240V	20A	60Hz	Accepts 18 - 12 AWG (SJT) (12 AWG JR cords)	Yellow	4-6mA	In-Line	cULus
26140010-6	120V	20A	60Hz	Accepts 18 - 12 AWG (SJT)	Black	30mA	In-Line	UR
25040101-3	240V	16A	60Hz	Accepts 18 - 12 AWG (SJT)	Black	10mA	In-Line	UR
14880002-6	120V	15A	60Hz	Accepts 18 - 12 AWG (SJT)	Yellow	4-6mA	Right Angle	cULus
14880232-6	120V	15A	60Hz	Accepts 18 - 12 AWG (SJT)	Black	4-6mA	Right Angle	cULus

16A | 20A PANEL MOUNTS



32360001-3

Shockshield™ panel mounts provide protection for personnel and equipment when leakage levels have a potentially lethal ground current.

- Trip point up to 10mA
- Less than 25mS trip response time
- Manual reset
- Ideal for equipment where mounting applications require panel or bulkhead mount
- Applications: Plant maintenance, equipment service

MODEL #	ELECTRICAL RATING			CORD GAUGE	ENCLOSURE COLOR	TRIP LEVEL	COMPLIANCE
32360001-3	120V	20A	60Hz	L & N - 12 AWG	Black	4-6mA	cURus
24220100-3	120V	20A	50/60Hz	Accepts 250V female quick disconnect terminals	Black	10mA Typical	UR
	240V	16A	50/60Hz				

SHOCKSHIELD™ | USER ATTACHABLES AND PANEL MOUNT

GFCI & ELCI

30A - 100A HIGH POWER GFCI | ELCI



24140002-1

HD Pro high power models provide protection for personnel and equipment when leakage levels have a potentially lethal ground current.

- Trip point up to 50mA
- 25mS trip response time (typically)
- Auto reset
- Engineered to trip within 25 milliseconds
- Applications: Plant maintenance, equipment service

MODEL #	ELECTRICAL RATING				CORD GAUGE	ENCLOSURE COLOR	TRIP LEVEL	PROTECTION TYPE
24520001-1	120V	60A	60Hz	1φ	4/3 AWG	Grey	10 mA	ELCI
24500006-1	208-240V	30A	60Hz	3φ	10/4 AWG	Black	10 mA	ELCI
24140002-1	240V	30A	60Hz	1φ	10/4 AWG	Black	10 mA	ELCI
24530001-1	240V	60A	60Hz	3φ	4/4 AWG	Grey	10 mA	ELCI
25560001-1	380V	60A	60Hz	3φ	4/4 AWG	Grey	30 mA	ELCI
24846001-1	208-240V	30A	60Hz	3φ	8/5 AWG	Grey	6, 10, & 30 mA	GFCI ELCI
24542001-1	208-240V	60A	60Hz	3φ	4/4 AWG	Grey	6, 10, & 30 mA	GFCI ELCI
24786001-1	208-240V	80A	60Hz	3φ	4/4 AWG	Grey	6, 10, & 30 mA	GFCI ELCI
24646001-1	480V	30A	60Hz	3φ	10/4 AWG	Grey	6, 10, & 30 mA	GFCI ELCI
24672001-1	480V	60A	60Hz	3φ	4/4 AWG	Grey	6, 10, & 30 mA	GFCI ELCI
24796001-1	480V	80A	60Hz	3φ	4/4 AWG	Grey	6, 10, & 30 mA	GFCI ELCI
24736001-1	480V	100A	60Hz	3φ	2/4 AWG	Grey	6, 10, & 30 mA	GFCI ELCI
44620001-1	480V	30A	60Hz	3φ	N/A	Tan	6, 10, & 30 mA	EGFPD GFCI ELCI
44630001-1	480V	60A	60Hz	3φ	N/A	Tan	6, 10, & 30 mA	EGFPD GFCI ELCI
44120012-1	480V	30A	60Hz	3φ	N/A	Tan	10, 30, & 50 mA	EGFPD ELCI
44130012-1	480V	60A	60Hz	3φ	N/A	Tan	10, 30, & 50 mA	EGFPD ELCI

HD PRO | HIGH POWER GFCI | ELCI

GFCI & ELCI

WIRING INSTRUCTIONS FOR HIGH POWER GFCI/ELCI

All high power GFCI/ELCI's must be suited for use with solidly grounded systems. The power cords must be connected according to the wiring instructions shown below.

WIRING INSTRUCTIONS			
12V, 277V UNIT	240V 1 ϕ UNIT	208/240V 3 ϕ UNIT	208/480/600V 3 ϕ UNIT
1. Black = Line	1. Black = Line	1. Black = Line	1. Black = Line
2. White = Neutral	2. Red (Pink) = Line	2. Red (Pink) = Line	2. Red (Pink) = Line
3. Green = Ground	3. White = Neutral	3. Orange (Blue) = Line	3. White = Line
	4. Green = Ground	4. White = Neutral	4. Green = Ground
		5. Green = Ground	

CIRCUITRY TYPE

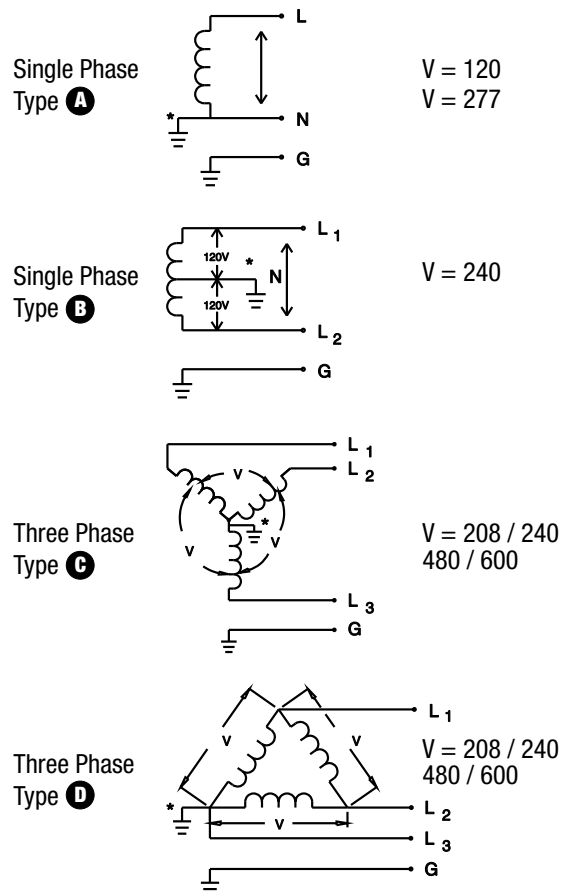

*Grounding Point May Vary

GFCI & ELCI | WIRE INSTRUCTIONS

COMPLIANCE

DEFINITIONS & STANDARDS

AFCI

Arc Fault Circuit Interrupters are designed to mitigate the effect of electrical arcs. Defined by UL 1699 they can be provided as circuit breakers, outlet devices, combination devices, adapters and cord sets. The AFCI must differentiate a normal arc (i.e., power tool, light switch, etc.) from a bad arc (i.e., a parallel fault in the wiring). To avoid nuisance tripping, the trip levels are quite higher and time longer than GFCI's, ALCIs or LCDIs. A cord type AFCI's maximum trip level is 75A for parallel fault and 5A for a series fault, both of which could be a fire in progress.

ALCI

Appliance Leakage Current Interrupters are a class of leakage current protection devices closely related to GFCI's. In fact, they share the same limits for trip level and response time. The main difference is that ALCI's are intended for use only in circuits with a solidly grounded neutral conductor.

EGFPD

Equipment Ground-Fault Protective Devices (EGFPD) These devices operate to disconnect the electric circuit from the source supply when the ground-fault current exceeds the ground-fault pick up level marked on the equipment. EGFPD's are intended to be installed only on grounded alternating-current systems IAW National Electric code. EGFPD's are intended for use in applications where ground-fault protection of equipment is required. EGFPD's are not intended to be used in place of GFCI where a GFCI is required by NEC.

ELCI

Equipment Leakage Circuit Interrupters are a class of LCPD not considered to be "people protectors," and are generally only intended for equipment protection. ELCI's are virtually identical with ALCIs with the exception that the trip level is set higher than 6mA.

GFCI

A Ground Fault Circuit Interrupter is an LCPD specifically intended for the protection of people from shock hazard. A GFCI is a device that will immediately stop the flow of electricity if it senses any voltage loss, whether the loss is through the ground wire or to your body.

LCDI

Leakage Current Detection Interrupter cord sets are intended to sense leakage currents flowing between or from conductors of the cord set and interrupt the circuit.

OSHA REGULATIONS

OSHA's scope of regulation covers three major business areas; the Construction Industry, the Maritime Industry and a third category, General Industry, which covers most other business enterprises except for those in mining and agriculture which are overseen by other government agencies. OSHA's regulations are Federal Law and are contained in the U.S. Government's Code of Federal Regulations (CFR). Violations of OSHA regulations can subject companies to legal action and fines.

NEC (NATIONAL ELECTRICAL CODE) STANDARDS

The National Electrical Code (NEC®) requires use of listed products to meet the requirements of various "Articles" within the code.

PRCD

Portable Residual Current Devices are designed for use in international applications and intended to protect people from electrical shock by interrupting the electrical circuit to a load when a fault current exceeds its rated trip level. They are compliant with IEC and NEMA standards, depending upon your country of use, and are available in 120V to 230V versions with 6-30mA trip levels.

UL STANDARDS

UL Listed products are used in applications where the product is not an integral part of the manufactured system. UL Listed wire and cable products are intended for use within residential, commercial or industrial buildings.

CONFIGURATIONS

NEMA CONFIGURATIONS

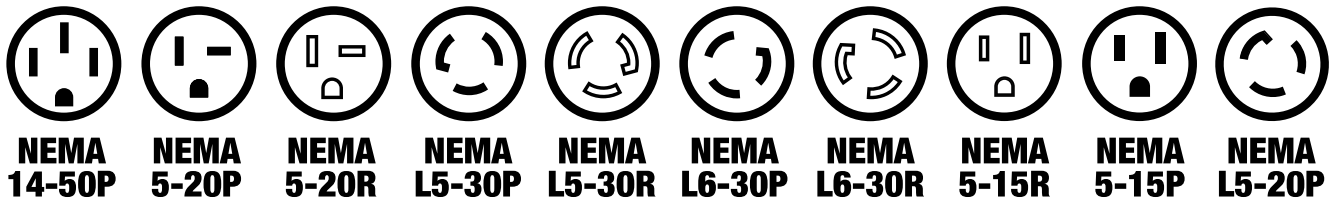

NEMA connectors are power plugs and receptacles used in North America and other countries that "follow the National Electrical Manufacturers Association's guidelines. systems have current ratings ranging from 15 to 60 amps (A) and voltage ratings ranging from 125 to 600 volts (V). Non-interchangeable connectors are made up of different combinations of contact blade widths, shapes, orientations, and dimensions that are specific to each voltage, electric current carrying power, and grounding method.

JACKET CONFIGURATIONS

S	SERVICE GRADE <i>(also means extra hard service when not followed by J, V, or P; normally rated to 600V)</i>
J	JUNIOR GRADE <i>(a "J" cord is rated for hard service up to 250-300V)</i>
E	THERMOPLASTIC ELASTOMER <i>(UL/NEC designation ONLY)</i>
O	OIL RESISTANT*
T	THERMOPLASTIC
W	OUTDOOR <i>Includes sunlight resistant jacket and wet location rated conductors (formerly "W-A")</i>

OSHA REGULATIONS

GROUND FAULT PROTECTION

29CFR1910.304(b)(3)(ii)(A) All 125-volt, single-phase, 15-, 20-, and 30-ampere receptacle outlets that are not part of the permanent wiring of the building or structure and that are in use by personnel shall have ground-fault circuit-interrupter protection for personnel.

Note 1 to paragraph (b)(3)(ii)(A) of this section: A cord connector on an extension cord set is considered to be a receptacle outlet if the cord set is used for temporary electric power.

Note 2 to paragraph (b)(3)(ii)(A) of this section: Cord sets and devices incorporating the required ground-fault circuit-interrupter that are connected to the receptacle closest to the source of power are acceptable forms of protection.

29CFR1910.304(b)(3)(ii)(B) Receptacles other than 125 volt, single-phase, 15-, 20-, and 30-ampere receptacles that are not part of the permanent wiring of the building or structure and that are in use by personnel shall have ground-fault circuit-interrupter protection for personnel.

29CFR1910.304(b)(3)(ii)(C) Where the ground-fault circuit-interrupter protection required by paragraph (b)(3)(ii)(B) of this section is not available for receptacles other than 125-volt, single-phase, 15-, 20-, and 30-ampere, the employer shall establish and implement an assured equipment grounding conductor program covering cord sets, receptacles that are not a part of the building or structure, and equipment connected by cord and plug that are available for use or used by employees on those receptacles. This program shall comply with the following requirements (2 pages...)

1926.404(b)(ii) Ground-fault circuit interrupters. All 120-volt, single-phase, 15- and 20-ampere receptacle outlets on construction sites, which are not a part of the permanent wiring of the building or structure and which are in use by employees, shall have approved ground-fault circuit interrupters for personnel protection. Receptacles on a two-wire, single-phase portable or vehicle-mounted generator rated not more than 5kW, where the circuit conductors of the generator are insulated from the generator frame and all other grounded surfaces, need not be protected with ground-fault circuit interrupters.

CORD PROTECTION

29CFR1910.304(b)(1) Examination. Electric equipment shall be free from recognized hazards that are likely to cause death or serious physical harm to employees. Safety of equipment shall be determined using the following considerations:

(viii) Other factors that contribute to the practical safeguarding of persons using or likely to come in contact with the equipment.

(7) Mechanical execution of work. Electric equipment shall be installed in a neat and workmanlike manner. 29CFR1910.305(a)(2)(x) Flexible cords and cables shall be protected from accidental damage, as might be caused, for example, by sharp corners, projections, and doorways or other pinch points. 29CFR1910.305(a)(2)(xi) Cable assemblies and flexible cords and cables shall be supported in place at intervals that ensure that they will be protected from physical damage. Support shall be in the form of staples, cables ties, straps, or similar type fittings installed so as not to cause damage.

1926.403 (b)(1) the employer shall ensure that electrical equipment is free from recognized hazards that are likely to cause death or serious physical harm to employees. Safety equipment shall be determined on the basis of the following considerations:

(vii) Other factors which contribute to the practical safeguarding of employees using or likely to come in contact with the equipment.

29CFR1926.405(a)(2)(ii)(B) Branch circuits shall originate in a power outlet or panelboard. Conductors shall be run as multi-conductor cord or cable assemblies or open conductors, or shall be run in raceways. All conductors shall be protected by over-current devices at their ampacity. Runs of open conductors shall be located where the conductors will not be subject to physical damage, and the conductors shall be fastened at intervals not exceeding 10 feet (3.05 m). No branch-circuit conductors shall be laid on the floor. Each branch circuit that supplies receptacles or fixed equipment shall contain a separate equipment grounding conductor if the branch circuit is run as open conductors.

29CFR1926.416(e)(1) Worn or frayed electric cords or cables shall not be used.

2020 NEC NEW STANDARDS IN GFCI PROTECTION

Article 210.63(A) for HVAC equipment & Article 210.63(B) for indoor service equipment and indoor equipment requiring dedicated space
HVAC equipment in a basement is currently covered in code requiring basement circuits to be GFCI protected. HVAC equipment located in attics and other tight area is not currently covered by any GFCI requirement. The CMP recognized that many HVAC areas are typically tight working spaces where technicians perform justified energized work (they can't troubleshoot a de-energized circuit). The 2020 code update assures equipment requiring service has a GFCI protected receptacle outlet that is readily accessible.

Article 210.8(F)

Code is updated for ALL outdoor outlets supplied by single phase branch circuits rated 150 volts to ground or less, 50 amps or less. This increased from 20 amps and now extends beyond receptacles to include ALL outlets and includes ALL hard-wired equipment.

The National Electrical Code (NEC®) requires use of listed products to meet the requirements of various "Articles" within the code.

We currently have the capability and current products that OEM and installers could use to comply with these changes without changing the electrical panel.

Existing in line models can be offered as an optional installation kit by the OEM's. The OEM could also choose to have an optional factory installed GFCI built into the equipment that would utilize our panel mount version.

2021 UL 943 GFCI CERTIFICATION REQUIREMENT CHANGES

WHEN IS IT EFFECTIVE: MAY 5, 2021

PARAGRAPHS AFFECTED

Paragraphs 5.16 and 6.27 have been revised to include the extension of Auto-monitoring and end of life requirements to ALL types of GFCI's

Paragraphs 6.31.2 (d) and (e) have been revised to improve the auto-monitoring function of permanently connected GFCI's

WHAT THE CHANGES MEAN

The changes to these paragraphs now requires ALL GFCI circuits to be provided with an auto-monitoring function. Prior to this change the auto-monitoring function was only applicable to permanently connected GFCI's. Now all GFCI's will be required to have periodic, automatic testing of the devices ability to respond to a ground fault. This test will occur each time the power becomes available to the load terminals and will be initiated within 5 seconds of power on and shall be repeated every three hours. If the auto-monitoring circuit detects a problem the circuit will deny power (trip with inability to reset) or trip with the ability to reset, subject to the next auto-monitoring test cycle.

****Southwire GFCI products will self test within 1/10th of a second, after power on, and will self test every 17 minutes****

Reason for the change

In layman's terms, currently, the user has to press the test button on a GFCI device to determine if the GFCI is operational. This is hazardous as many GFCI users do not test the circuit prior to use or during the GFCI lifecycle. Auto-monitoring ensures the GFCI is ALWAYS operational against a potential life threatening ground fault event without user intervention.



Southwire™

ELECTRONIC SOLUTIONS CATALOG

get social with us:



/SOUTHWIRETOOLS



/SOUTHWIRE-COMPANY



@SOUTHWIRETOOLS



@SOUTHWIRE

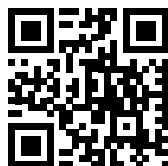

SCAN TO LEARN MORE

WWW.SOUTHWIRE.COM | 1-855-SWTTOOLS

All Trademarks or Registered Trademarks (TM/®) are owned or licensed by Southwire Company.
Any other TM/®- Trademark or Registered Trademark of Southwire Company.